

# OPA818 2.7-GHz, High-Voltage, FET-Input, Low Noise, Operational Amplifier

## 1 Features

- High speed:
  - Gain-bandwidth product: 2.7 GHz
  - Bandwidth ( $G = 7 \text{ V/V}$ ): 765 MHz
  - Large-signal bandwidth ( $2 V_{PP}$ ): 400 MHz
  - Slew rate: 1400 V/ $\mu\text{s}$
- Decompensated gain: 7-V/V stable
- Low noise:
  - Input voltage noise: 2.2 nV/ $\sqrt{\text{Hz}}$
  - Input current noise: 3 fA/ $\sqrt{\text{Hz}}$  ( $f = 10 \text{ kHz}$ )
- Input bias current: 4 pA (typical)
- Low input capacitance:
  - Common-mode: 1.9 pF
  - Differential mode: 0.5 pF
- Low distortion ( $G = 7 \text{ V/V}$ ,  $R_L = 1 \text{ k}\Omega$ ,  $V_O = 2 V_{PP}$ ):
  - HD2, HD3 at 1 MHz:  $-104 \text{ dBc}$ ,  $-108 \text{ dBc}$
  - HD2, HD3 at 50 MHz:  $-57 \text{ dBc}$ ,  $-72 \text{ dBc}$
- Wide supply range: 6 V to 13 V
- Output swing: 8  $V_{PP}$  ( $V_S = 10 \text{ V}$ )
- Supply current: 27.7 mA
- Shutdown supply current: 27  $\mu\text{A}$
- Performance upgrade to [OPA657](#)

## 2 Applications

- [Wideband transimpedance amplifiers \(TIAs\)](#)
- [Wafer scanning equipment](#)
- [Optical communication modules](#)
- [High-speed data acquisition \(DAQ\)](#)
- [Active probes](#)
- [Optical time-domain reflectometry \(OTDR\)](#)
- [Test and measurement front-ends](#)
- [Medical and chemical analyzers](#)

## 3 Description

The OPA818 is a decompensated, voltage-feedback operational amplifier for high-speed and wide dynamic range applications. OPA818 has a low-noise junction gate field-effect transistor (JFET) input stage that combines high gain-bandwidth with a wide supply range from 6 V to 13 V. The fast slew rate of 1400 V/ $\mu\text{s}$  provides high large-signal bandwidth and low distortion. This amplifier is manufactured using Texas Instruments' proprietary, high-speed, silicon-germanium (SiGe) process to achieve significant performance improvements over other high-speed, FET-input amplifiers.

The OPA818 is an extremely versatile, wideband TIA photodiode amplifier for use in optical test and communication equipment, and many medical, scientific, and industrial instruments. The OPA818 showcases 2.7 GHz gain-bandwidth, low 2.4 pF total input capacitance, and 2.2 nV/ $\sqrt{\text{Hz}}$  input noise. The OPA818 can achieve over 85-MHz signal bandwidth in TIA configuration with 20-k $\Omega$  TIA gain ( $R_F$ ) and 0.5-pF photodiode capacitance ( $C_D$ ) with wide output swings. The decompensated, low-noise architecture with pico amperes of input bias current is also well-suited for high-gain test and measurement applications. Though normally stable in gains  $\geq 7 \text{ V/V}$ , the OPA818 can be used in applications with lower gains by applying noise-gain shaping techniques (see [Non-Inverting Gain of 2 V/V](#)).

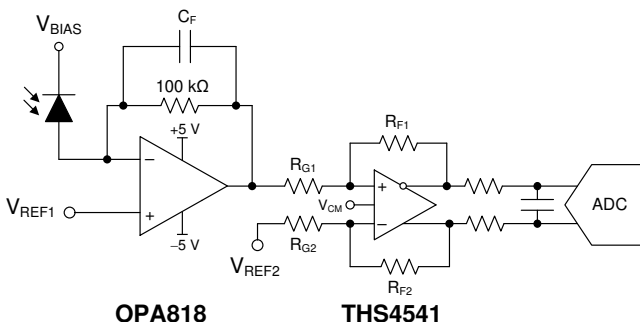
The OPA818 is available in an 8-lead WSON package with an exposed thermal pad for heat dissipation. This device is specified to operate over the industrial temperature range of  $-40^\circ\text{C}$  to  $+85^\circ\text{C}$ .

### Device Information<sup>(1)</sup>

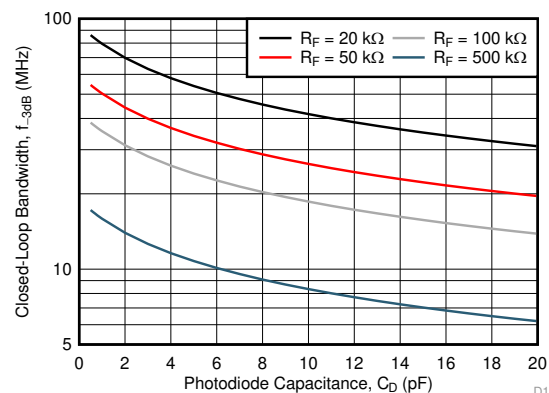
PART NUMBER	PACKAGE	BODY SIZE (NOM)
OPA818	WSON (8)	3.00 mm x 3.00 mm

(1) For all available packages, see the package option addendum at the end of the data sheet.

### High-Speed Optical Front-End



### Photodiode Capacitance vs 3-dB Bandwidth



D100



## Table of Contents

<b>1 Features</b> .....	<b>1</b>	8.4 Device Functional Modes.....	<b>18</b>
<b>2 Applications</b> .....	<b>1</b>	<b>9 Application and Implementation</b> .....	<b>19</b>
<b>3 Description</b> .....	<b>1</b>	9.1 Application Information.....	<b>19</b>
<b>4 Revision History</b> .....	<b>2</b>	9.2 Typical Applications .....	<b>21</b>
<b>5 Device Comparison Table</b> .....	<b>3</b>	<b>10 Power Supply Recommendations</b> .....	<b>24</b>
<b>6 Pin Configuration and Functions</b> .....	<b>4</b>	<b>11 Layout</b> .....	<b>25</b>
<b>7 Specifications</b> .....	<b>5</b>	11.1 Layout Guidelines .....	<b>25</b>
7.1 Absolute Maximum Ratings .....	<b>5</b>	11.2 Layout Example .....	<b>26</b>
7.2 ESD Ratings.....	<b>5</b>	<b>12 Device and Documentation Support</b> .....	<b>28</b>
7.3 Recommended Operating Conditions.....	<b>5</b>	12.1 Device Support .....	<b>28</b>
7.4 Thermal Information .....	<b>5</b>	12.2 Documentation Support .....	<b>28</b>
7.5 Electrical Characteristics: $V_S = \pm 5\text{ V}$ .....	<b>6</b>	12.3 Receiving Notification of Documentation Updates	<b>28</b>
7.6 Typical Characteristics: $V_S = \pm 5\text{ V}$ .....	<b>8</b>	12.4 Community Resources.....	<b>28</b>
7.7 Typical Characteristics: $V_S = 6\text{ V}$ .....	<b>14</b>	12.5 Trademarks .....	<b>28</b>
<b>8 Detailed Description</b> .....	<b>15</b>	12.6 Electrostatic Discharge Caution.....	<b>28</b>
8.1 Overview .....	<b>15</b>	12.7 Glossary .....	<b>28</b>
8.2 Functional Block Diagram .....	<b>15</b>	<b>13 Mechanical, Packaging, and Orderable</b>	
8.3 Feature Description.....	<b>15</b>	<b>Information</b> .....	<b>28</b>

## 4 Revision History

NOTE: Page numbers for previous revisions may differ from page numbers in the current version.

Changes from Original (May 2019) to Revision A	Page
• Changed document status From: <i>Advance Information</i> To: <i>Production Data</i> .....	<b>1</b>

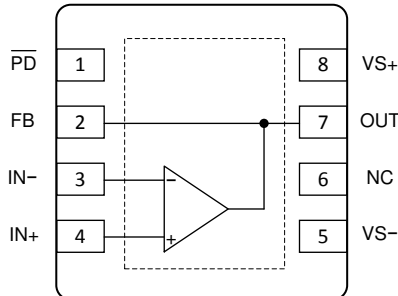
## 5 Device Comparison Table

DEVICE	V <sub>S</sub> (V)	BW (MHz)	Input	SLEW RATE (V/μs)	VOLTAGE NOISE (nV/√Hz)	MINIMUM STABLE GAIN (V/V)
<a href="#">OPA818</a>	±6.5	2700	FET	1400	2.2	7
<a href="#">OPA657</a>	±5	1600	FET	700	4.8	7
<a href="#">OPA656</a>	±5	230	FET	290	7	1
<a href="#">OPA659</a>	±6	350	FET	2550	8.9	1
<a href="#">LMH6629</a> <sup>(1)</sup>	±2.5	800 or 4000	BJT	530 or 1600	0.69	4 or 10
<a href="#">OPA858</a>	±2.5	5500	CMOS	2000	2.5	7
<a href="#">THS4631</a>	±15	210	FET	1000	7	1

(1) Pin selectable compensation.

## 6 Pin Configuration and Functions

DRG Package  
8-Pin WSON With Thermal Pad  
Top View



NC - no internal connection

### Pin Functions

PIN		TYPE	DESCRIPTION
NAME	WSON		
FB	2	Output	Feedback resistor connection (optional)
IN-	3	Input	Inverting input
IN+	4	Input	Non-inverting input
NC	6	—	No connect (no internal connection to die)
OUT	7	Output	Output of amplifier
$\overline{PD}$	1	Input	Power down (low = enable, high = disable); internal 1-M $\Omega$ pull-up allows floating this pin
VS-	5	Power	Negative power supply
VS+	8	Power	Positive power supply
Thermal pad		—	Electrically isolated from the die substrate but ESD diodes down-bonded to the thermal pad. Recommended connection to a heat spreading plane, typically GND.

## 7 Specifications

### 7.1 Absolute Maximum Ratings

Over operating free-air temperature range (unless otherwise noted).<sup>(1)</sup>

		MIN	MAX	UNIT
Voltage	Supply voltage, $(V_{S+}) - (V_{S-})$		13.5	V
	Differential input voltage		±5	
	Common-mode input voltage	$V_{S-} - 0.5$	$V_{S-} + 10$	
	Output voltage	$V_{S-} - 0.5$	$V_{S+} + 0.5$	
Current	Continuous input current		±10	mA
	Continuous output current <sup>(2)</sup>		25	
	Continuous current in feedback pin <sup>(2)</sup>		13	
Temperature	Junction, $T_J$		125	°C
	Operating free-air, $T_A$	-40	85	
	Storage, $T_{stg}$	-65	150	

(1) Stresses beyond those listed under *Absolute Maximum Ratings* may cause permanent damage to the device. These are stress ratings only, which do not imply functional operation of the device at these or any other conditions beyond those indicated under *Recommended Operating Conditions*. Exposure to absolute-maximum-rated conditions for extended periods may affect device reliability.

(2) Long-term continuous current for electromigration limits.

### 7.2 ESD Ratings

			VALUE	UNIT
$V_{(ESD)}$	Electrostatic discharge	Human body model (HBM), per ANSI/ESDA/JEDEC JS-001, allpins <sup>(1)</sup>	±2500	V
		Charged device model (CDM), per JEDEC specification JESD22-C101, all pins <sup>(2)</sup>	±1000	

(1) JEDEC document JEP155 states that 500-V HBM allows safe manufacturing with a standard ESD control process.

(2) JEDEC document JEP157 states that 250-V CDM allows safe manufacturing with a standard ESD control process.

### 7.3 Recommended Operating Conditions

Over operating free-air temperature range (unless otherwise noted).

		MIN	NOM	MAX	UNIT
$V_S$	Single-supply voltage	6	10	13	V
$T_A$	Ambient temperature	-40	25	85	°C

### 7.4 Thermal Information

THERMAL METRIC <sup>(1)</sup>		OPA818	UNIT
		DRG (SON)	
		8 PINS	
$R_{\theta JA}$	Junction-to-ambient thermal resistance	54.6	°C/W
$R_{\theta JC(top)}$	Junction-to-case (top) thermal resistance	56.0	°C/W
$R_{\theta JB}$	Junction-to-board thermal resistance	27.2	°C/W
$\Psi_{JT}$	Junction-to-top characterization parameter	1.8	°C/W
$\Psi_{JB}$	Junction-to-board characterization parameter	27.2	°C/W
$R_{\theta JC(bot)}$	Junction-to-case (bottom) thermal resistance	11.1	°C/W

(1) For more information about traditional and new thermal metrics, see the [Semiconductor and IC Package Thermal Metrics](#) application report.

## 7.5 Electrical Characteristics: $V_S = \pm 5\text{ V}$

At  $T_A \approx 25^\circ\text{C}$ ,  $V_{S+} = +5\text{ V}$ ,  $V_{S-} = -5\text{ V}$ , closed-loop gain ( $G$ ) = 7 V/V, common-mode voltage ( $V_{CM}$ ) = mid-supply,  $R_F = 301\ \Omega$ ,  $R_L = 100\ \Omega$  to mid-supply (unless otherwise noted).

PARAMETER		TEST CONDITIONS	MIN	TYP	MAX	UNIT
<b>AC PERFORMANCE</b>						
SSBW	Small-signal bandwidth	$V_O = 100\text{ mV}_{PP}$		765		MHz
		$G = 10$ , $V_O = 100\text{ mV}_{PP}$		430		
	Frequency response peaking			1.4		dB
LSBW	Large-signal bandwidth	$V_O = 2\text{ V}_{PP}$		400		MHz
GBWP	Gain-bandwidth product	$G = 101\text{ V/V}$ , $V_O = 100\text{ mV}_{PP}$ , $R_F = 3.01\text{ k}\Omega$		2700		MHz
	Bandwidth for 0.1dB flatness	$V_O = 100\text{ mV}_{PP}$		100		MHz
SR	Slew rate (20%-80%)	$V_O = 4\text{-V step}$ , rising and falling		1400		V/ $\mu\text{s}$
		$V_O = 4\text{-V step}$ , rising and falling, $G = 10$		1340		V/ $\mu\text{s}$
$t_r/t_f$	Rise and fall time (10%-90%)	$V_O = 100\text{-mV step}$		0.52		ns
$t_s$	Settling time to 0.1%	$V_O = 2\text{-V step}$		5.7		ns
	Overshoot and undershoot	$V_O = 2\text{-V step}$		7%		
	Overdrive recovery time	$V_O = (V_{S-} - 1\text{ V})$ to $(V_{S+} + 1\text{ V})$		25		ns
HD2	Second-order harmonic distortion	$V_O = 2\text{ V}_{PP}$	$f = 1\text{ MHz}$		-84	dBc
			$f = 10\text{ MHz}$		-64	
			$f = 50\text{ MHz}$		-52	
			$f = 10\text{ MHz}$ , $R_L = 1\text{ k}\Omega$		-71	
HD3	Third-order harmonic distortion	$V_O = 2\text{ V}_{PP}$	$f = 1\text{ MHz}$		-106	dBc
			$f = 10\text{ MHz}$		-99	
			$f = 50\text{ MHz}$		-74	
			$f = 10\text{ MHz}$ , $R_L = 1\text{ k}\Omega$		-82	
$e_n$	Input voltage noise	$f \geq 150\text{ kHz}$		2.2		nV/ $\sqrt{\text{Hz}}$
		1/f corner		15		kHz
$i_n$	Input current noise	$f = 10\text{ kHz}$		3		fA/ $\sqrt{\text{Hz}}$
		$f = 1\text{ MHz}$		145		fA/ $\sqrt{\text{Hz}}$
$Z_{CL}$	Closed-loop output impedance	$f = 10\text{ MHz}$		0.2		$\Omega$
<b>DC PERFORMANCE</b>						
$A_{OL}$	Open-loop voltage gain	$f = \text{DC}$ , $V_O = \pm 2\text{ V}$	85	92		dB
$V_{OS}$	Input offset voltage			$\pm 0.35$	$\pm 1.25$	mV
		$T_A = -40^\circ\text{C}$ to $+85^\circ\text{C}$			$\pm 1.8$	
	Input offset voltage drift <sup>(1)</sup>	$T_A = -40^\circ\text{C}$ to $+85^\circ\text{C}$		$\pm 3$	$\pm 20$	$\mu\text{V}/^\circ\text{C}$
$I_B$	Input bias current <sup>(2)</sup>			$\pm 4$	$\pm 25$	$\mu\text{A}$
		$T_A = -40^\circ\text{C}$ to $+85^\circ\text{C}$				
$I_{OS}$	Input offset current <sup>(2)</sup>			$\pm 1$	$\pm 25$	$\mu\text{A}$
CMRR	Common-mode rejection ratio	$f = \text{DC}$ , $V_{CM} = \pm 0.5\text{ V}$	73	90		dB
		$f = \text{DC}$ , $V_{CM} = \pm 0.5\text{ V}$ , $T_A = -40^\circ\text{C}$ to $+85^\circ\text{C}$	70			dB
	Internal feedback trace resistance	Device turned OFF, OUT to FB pin resistance	0.8	1.2	1.7	$\Omega$

(1) Input offset voltage drift and input bias current drift are average values calculated by taking data at the end-points, computing the difference, and dividing by the temperature range.

(2) Current is considered positive out of the pin.  $I_{OS} = I_{B+} - I_{B-}$ .

**Electrical Characteristics:  $V_S = \pm 5\text{ V}$  (continued)**

At  $T_A \approx 25^\circ\text{C}$ ,  $V_{S+} = +5\text{ V}$ ,  $V_{S-} = -5\text{ V}$ , closed-loop gain ( $G$ ) = 7 V/V, common-mode voltage ( $V_{CM}$ ) = mid-supply,  $R_F = 301\ \Omega$ ,  $R_L = 100\ \Omega$  to mid-supply (unless otherwise noted).

PARAMETER		TEST CONDITIONS	MIN	TYP	MAX	UNIT	
<b>INPUT</b>							
	Common-mode input impedance		500    1.9			G $\Omega$    pF	
	Differential input impedance		500    0.5			G $\Omega$    pF	
	Most positive input voltage <sup>(3)</sup>		$V_{S+} - 3.6$	$V_{S+} - 3.2$		V	
	Most negative input voltage <sup>(3)</sup>			$V_{S-}$	$V_{S-} + 0.25$	V	
	$\Delta V_{OS}$ at most positive input voltage <sup>(4)</sup>	$V_{CM} = V_{S+} - 3.6\text{ V}$	$\pm 0.03$			$\pm 1$	mV
		$V_{CM} = V_{S+} - 3.6\text{ V}$ , $T_A = -40^\circ\text{C}$ to $+85^\circ\text{C}$				$\pm 1.5$	mV
	$\Delta V_{OS}$ at most negative input voltage <sup>(4)</sup>	$V_{CM} = V_{S-} + 0.25\text{ V}$	$\pm 0.23$			$\pm 1$	mV
		$V_{CM} = V_{S-} + 0.25\text{ V}$ , $T_A = -40^\circ\text{C}$ to $+85^\circ\text{C}$				$\pm 1.5$	mV
<b>OUTPUT</b>							
$V_{OH}$	Output voltage swing high		$V_{S+} - 1.2$	$V_{S+} - 1$		V	
		$T_A = -40^\circ\text{C}$ to $+85^\circ\text{C}$	$V_{S+} - 1.3$			V	
		$R_L = 1\text{ k}\Omega$	$V_{S+} - 1$	$V_{S+} - 0.9$		V	
		$R_L = 1\text{ k}\Omega$ , $T_A = -40^\circ\text{C}$ to $+85^\circ\text{C}$	$V_{S+} - 1.2$			V	
$V_{OL}$	Output voltage swing low			$V_{S-} + 1.2$	$V_{S-} + 1.33$	V	
		$T_A = -40^\circ\text{C}$ to $+85^\circ\text{C}$	$V_{S-} + 1.4$			V	
		$R_L = 1\text{ k}\Omega$		$V_{S-} + 1.1$	$V_{S-} + 1.2$	V	
		$R_L = 1\text{ k}\Omega$ , $T_A = -40^\circ\text{C}$ to $+85^\circ\text{C}$	$V_{S-} + 1.3$			V	
$I_{O\_MAX}$	Linear output drive	$V_O = \pm 2.75\text{ V}$ , $R_L$ to mid-supply = $50\ \Omega$ , $[\Delta V_{OS}$ from no-load $V_{OS}] \leq \pm 1\text{ mV}$	$\pm 55$			mA	
		$V_O = \pm 2.5\text{ V}$ , $R_L$ to mid-supply = $50\ \Omega$ , $[\Delta V_{OS}$ from no-load $V_{OS}] \leq \pm 1\text{ mV}$ , $T_A = -40^\circ\text{C}$ to $+85^\circ\text{C}$	$\pm 50$			mA	
$I_{SC}$	Output short-circuit current		$\pm 110$			mA	
<b>POWER SUPPLY</b>							
$V_S$	Single-supply operating range		6	10	13	V	
$I_Q$	Quiescent current per channel	No load	26.5	27.7	29	mA	
		No load, $T_A = -40^\circ\text{C}$ to $+85^\circ\text{C}$	23		31.5	mA	
	$I_Q$ drift	No load, $T_A = -40^\circ\text{C}$ to $+85^\circ\text{C}$	42			$\mu\text{A}/^\circ\text{C}$	
PSRR+	Positive power supply rejection ratio	$\Delta V_{S+} = \pm 0.25\text{ V}$	75	95		dB	
		$\Delta V_{S+} = \pm 0.25\text{ V}$ , $T_A = -40^\circ\text{C}$ to $+85^\circ\text{C}$	70			dB	
PSRR-	Negative power supply rejection ratio	$\Delta V_{S-} = \pm 0.25\text{ V}$	80	94		dB	
		$\Delta V_{S-} = \pm 0.25\text{ V}$ , $T_A = -40^\circ\text{C}$ to $+85^\circ\text{C}$	74			dB	
<b>POWER DOWN</b>							
$V_{TH\_EN}$	Enable voltage threshold	Power on when $\overline{PD} > V_{TH\_EN}$ , No Load	$V_{S+} - 1$			V	
$V_{TH\_DIS}$	Disable voltage threshold	Power down when $\overline{PD} < V_{TH\_DIS}$ , No Load	$V_{S+} - 3$			V	
	Power-down $I_Q$ ( $V_{S+}$ )	No Load		27	40	$\mu\text{A}$	
	$\overline{PD}$ pin bias current <sup>(2)</sup>	No load, $\overline{PD} = V_{S+}$	-3	-2		$\mu\text{A}$	
		No load, $\overline{PD} = V_{S-}$		13	20	$\mu\text{A}$	
	Turn-on time delay			125		ns	
	Turn-off time delay			170		ns	

(3) Defined by  $\Delta V_{OS}$  at most positive/negative input voltage specification

(4)  $\Delta V_{OS} = |V_{OS}$  at specified  $V_{CM} - V_{OS}$  at  $0\text{ V } V_{CM}$ |

### 7.6 Typical Characteristics: $V_S = \pm 5\text{ V}$

At  $T_A \approx 25^\circ\text{C}$ ,  $V_{S+} = +5\text{ V}$ ,  $V_{S-} = -5\text{ V}$ , closed-loop gain ( $G$ ) = 7 V/V,  $V_{CM}$  = mid-supply,  $R_F = 301\ \Omega$ ,  $R_L = 100\ \Omega$  to mid-supply, small-signal  $V_O = 100\text{ mV}_{PP}$ , large-signal  $V_O = 2\text{ V}_{PP}$  (unless otherwise noted).

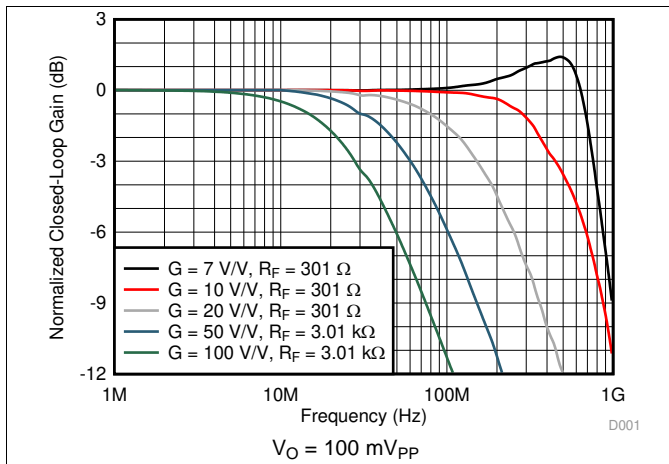


Figure 1. Non-Inverting Small-Signal Frequency Response

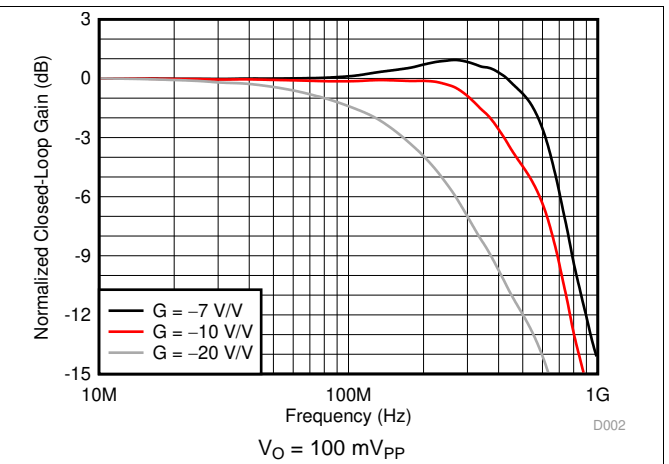


Figure 2. Inverting Small-Signal Frequency Response

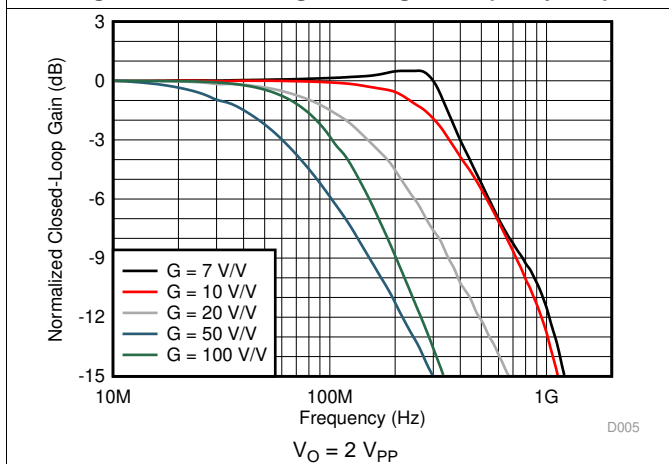


Figure 3. Non-Inverting Large-Signal Frequency Response

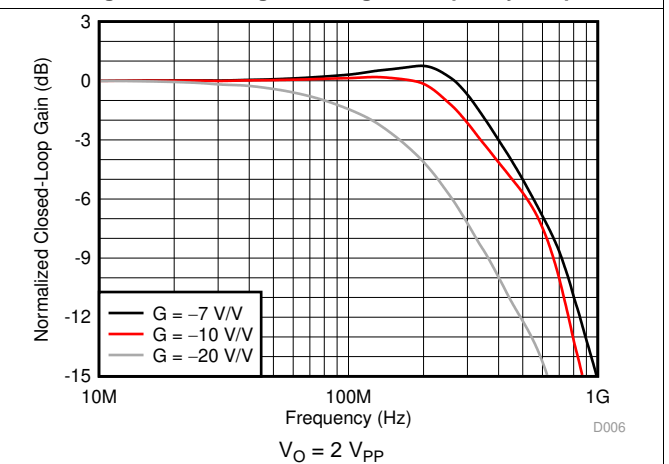


Figure 4. Inverting Large-Signal Frequency Response

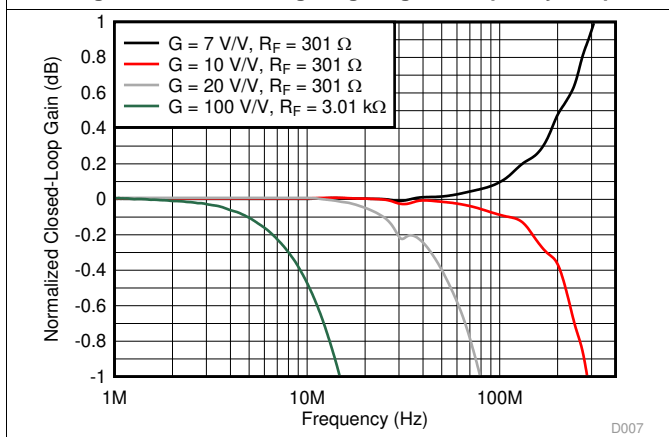


Figure 5. Gain Flatness vs Frequency

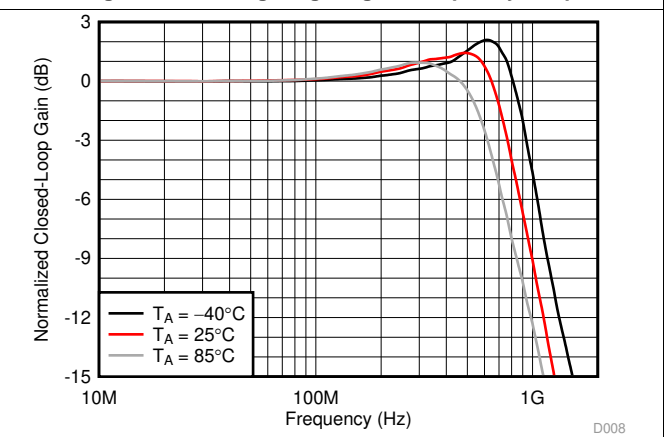


Figure 6. Non-Inverting Small-Signal Frequency Response Over Temperature



Typical Characteristics:  $V_S = \pm 5\text{ V}$  (continued)

At  $T_A \approx 25^\circ\text{C}$ ,  $V_{S+} = +5\text{ V}$ ,  $V_{S-} = -5\text{ V}$ , closed-loop gain ( $G$ ) =  $7\text{ V/V}$ ,  $V_{CM}$  = mid-supply,  $R_F = 301\ \Omega$ ,  $R_L = 100\ \Omega$  to mid-supply, small-signal  $V_O = 100\text{ mV}_{PP}$ , large-signal  $V_O = 2\text{ V}_{PP}$  (unless otherwise noted).

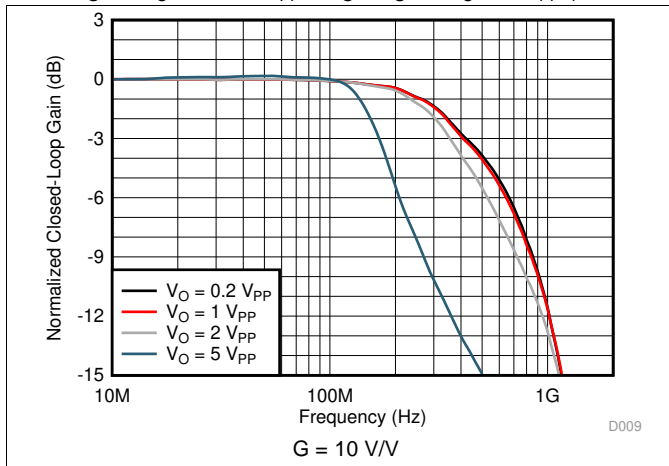


Figure 7. Non-Inverting Frequency Response Over Output Swing

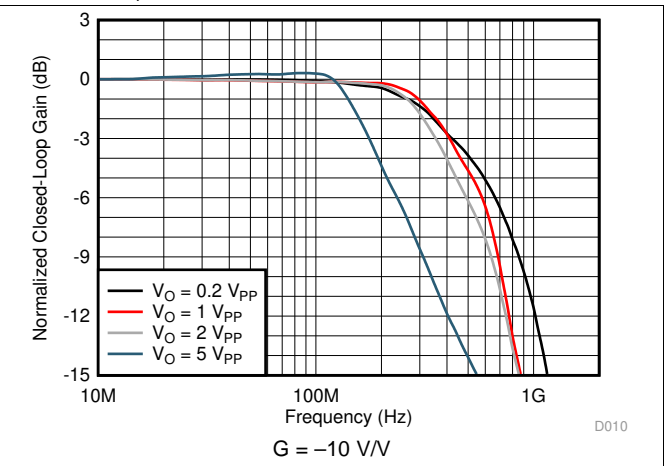


Figure 8. Inverting Frequency Response Over Output Swing

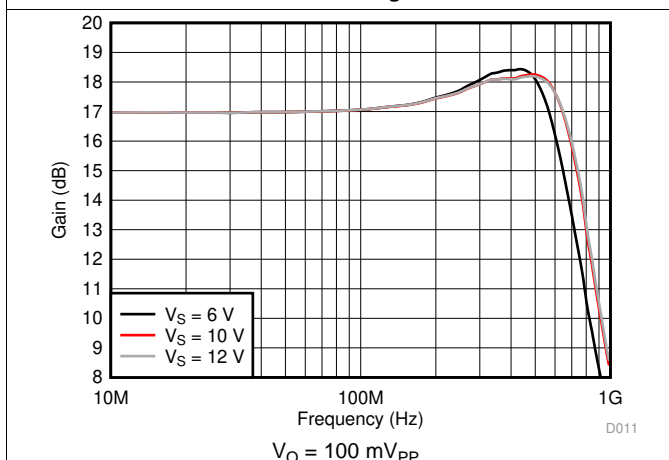


Figure 9. Non-Inverting Small-Signal Frequency Response Over Voltage Supply

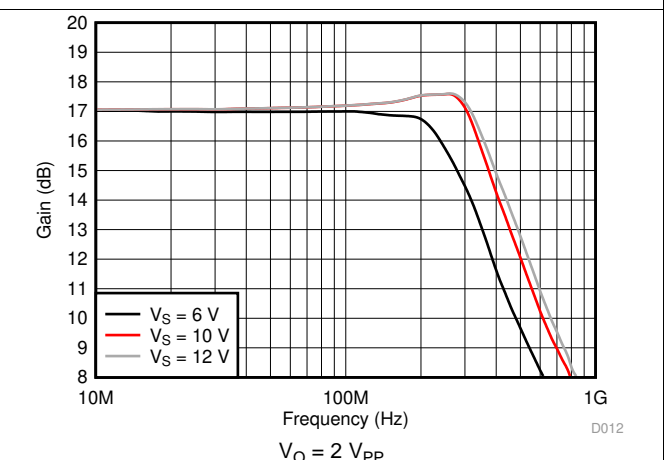


Figure 10. Non-Inverting Large-Signal Frequency Response Over Voltage Supply

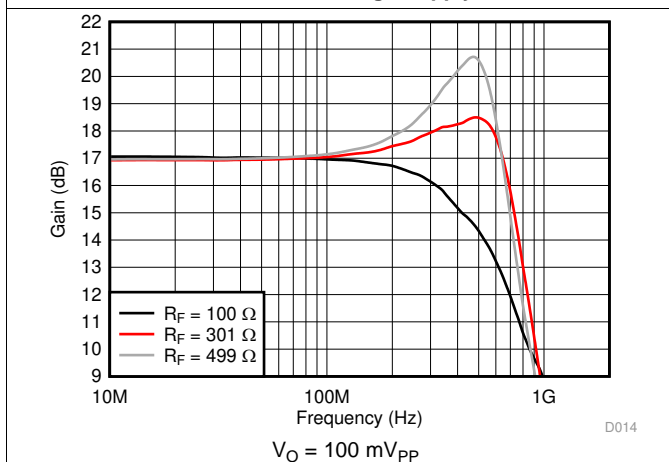


Figure 11. Non-Inverting Small-Signal Frequency Response Over  $R_F$

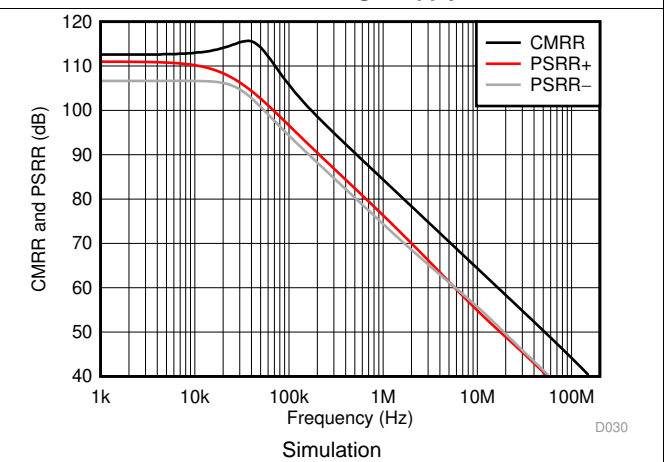
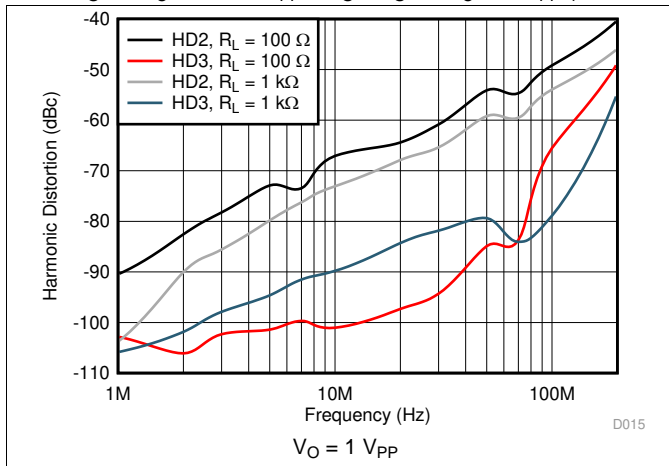


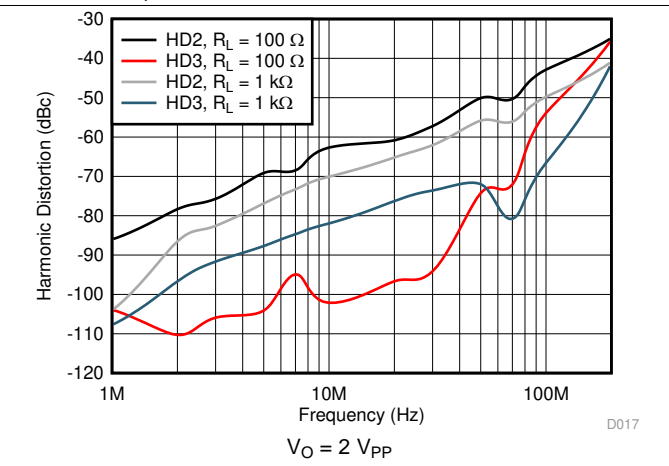
Figure 12. Common-Mode and Power-Supply Rejection Ratio vs Frequency

**Typical Characteristics:  $V_S = \pm 5\text{ V}$  (continued)**

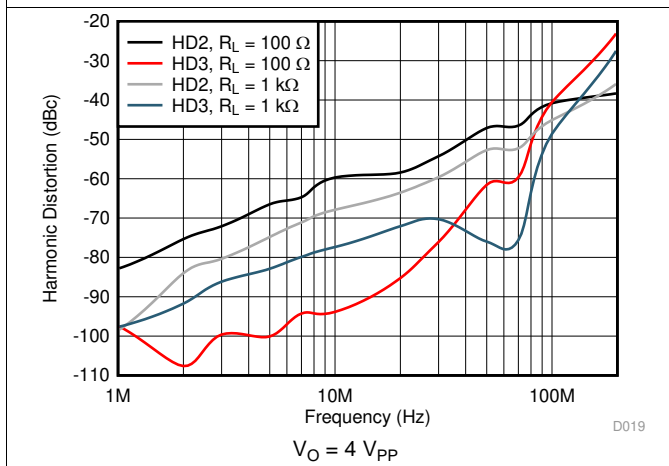
At  $T_A \approx 25^\circ\text{C}$ ,  $V_{S+} = +5\text{ V}$ ,  $V_{S-} = -5\text{ V}$ , closed-loop gain ( $G$ ) =  $7\text{ V/V}$ ,  $V_{CM}$  = mid-supply,  $R_F = 301\ \Omega$ ,  $R_L = 100\ \Omega$  to mid-supply, small-signal  $V_O = 100\text{ mV}_{PP}$ , large-signal  $V_O = 2\text{ V}_{PP}$  (unless otherwise noted).



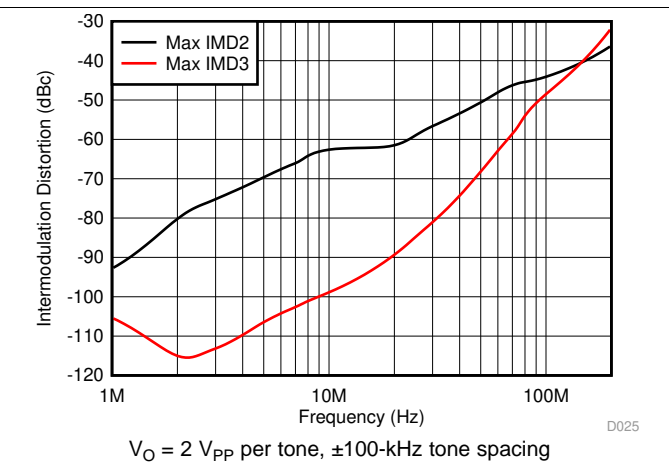
**Figure 13. Harmonic Distortion vs Frequency Over  $R_L$**



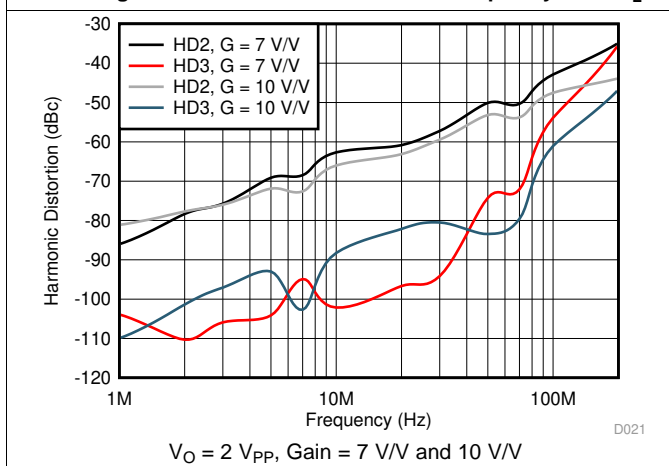
**Figure 14. Harmonic Distortion vs Frequency Over  $R_L$**



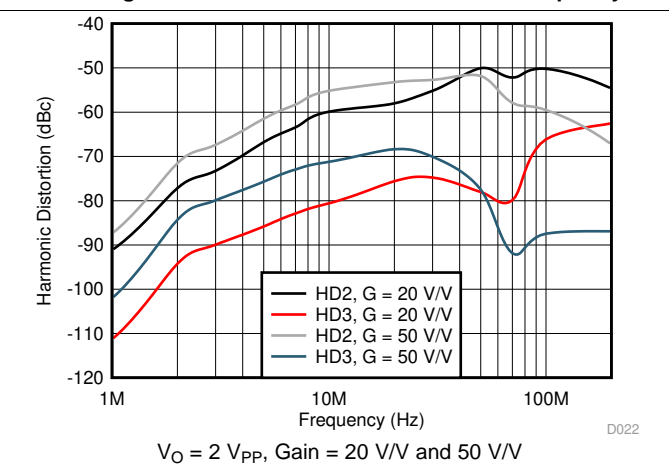
**Figure 15. Harmonic Distortion vs Frequency Over  $R_L$**



**Figure 16. Intermodulation Distortion vs Frequency**



**Figure 17. Harmonic Distortion vs Frequency Over Gain**



**Figure 18. Harmonic Distortion vs Frequency Over Gain**  
Flattening HD at higher frequencies due to bandwidth roll-off

Typical Characteristics:  $V_S = \pm 5\text{ V}$  (continued)

At  $T_A \approx 25^\circ\text{C}$ ,  $V_{S+} = +5\text{ V}$ ,  $V_{S-} = -5\text{ V}$ , closed-loop gain ( $G$ ) = 7 V/V,  $V_{CM}$  = mid-supply,  $R_F = 301\ \Omega$ ,  $R_L = 100\ \Omega$  to mid-supply, small-signal  $V_O = 100\text{ mV}_{PP}$ , large-signal  $V_O = 2\text{ V}_{PP}$  (unless otherwise noted).

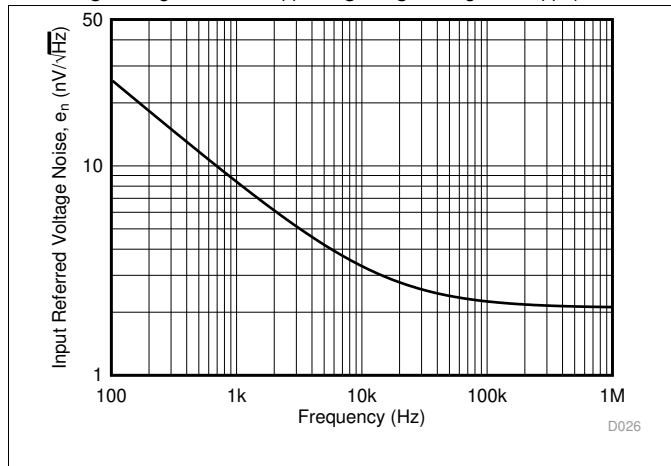


Figure 19. Voltage Noise Density vs Frequency

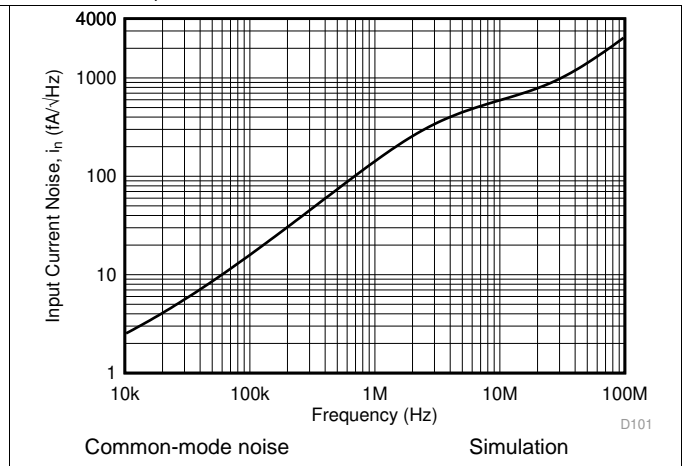


Figure 20. Current Noise Density vs Frequency

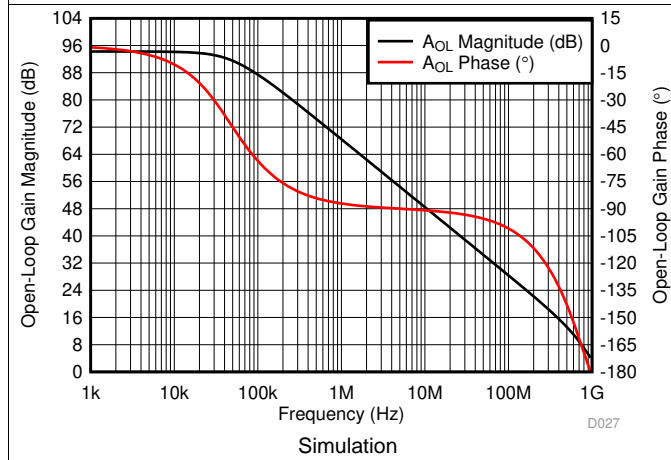


Figure 21. Open-Loop Gain Magnitude and Phase vs Frequency

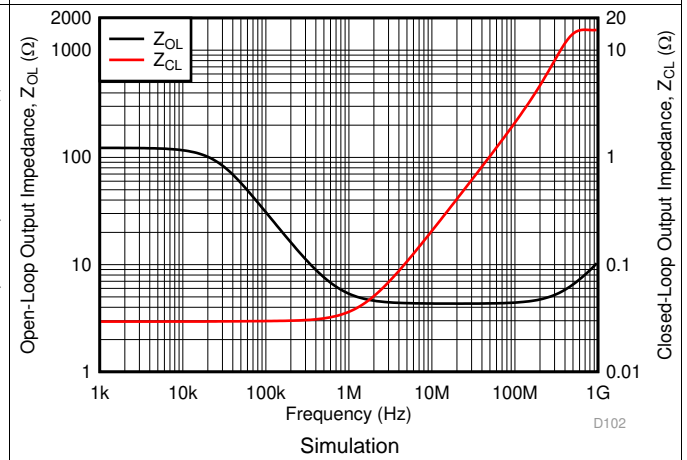


Figure 22. Open-Loop and Closed-Loop Output Impedance vs Frequency

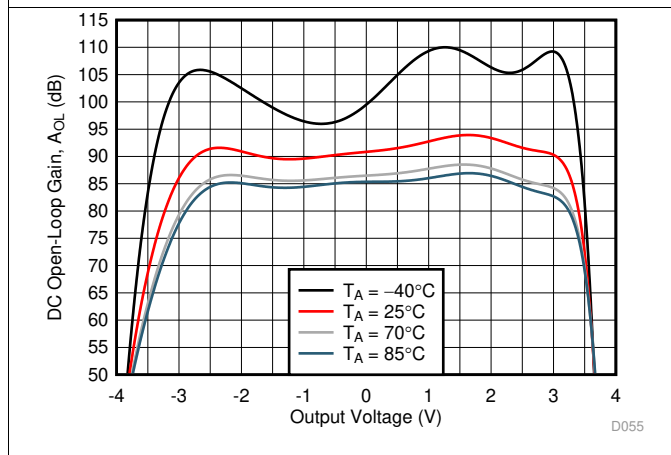


Figure 23. DC Open-Loop Gain vs Output Voltage

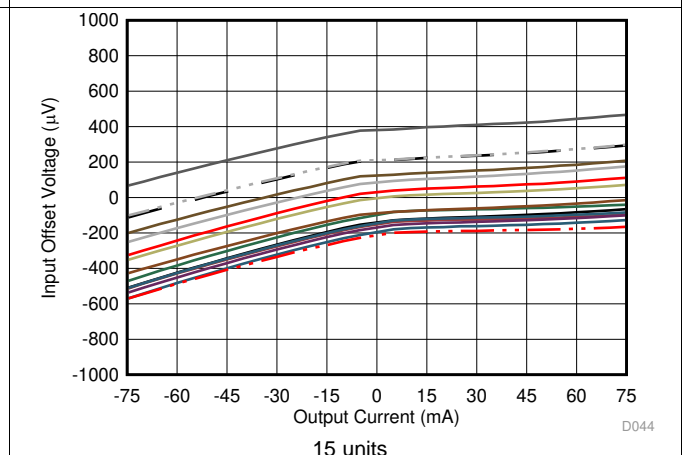
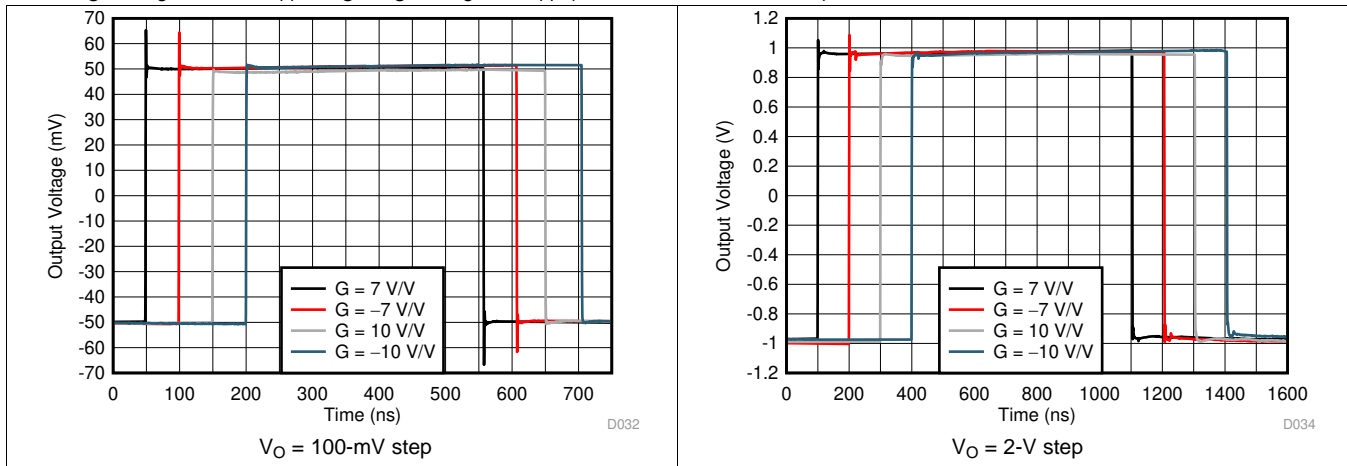


Figure 24. Input Offset Voltage vs Output Current

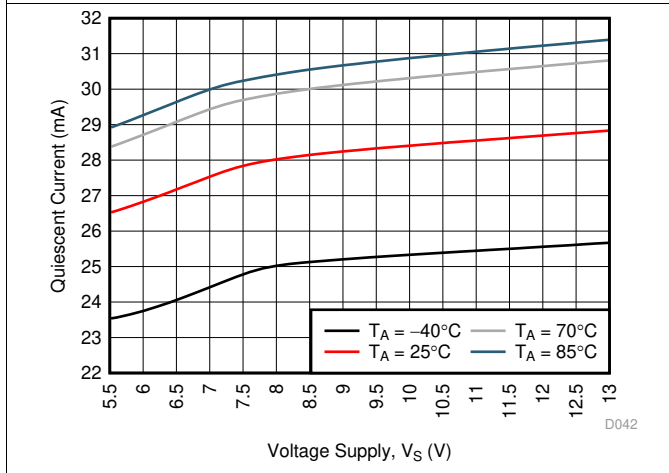
**Typical Characteristics:  $V_S = \pm 5\text{ V}$  (continued)**

At  $T_A \approx 25^\circ\text{C}$ ,  $V_{S+} = +5\text{ V}$ ,  $V_{S-} = -5\text{ V}$ , closed-loop gain ( $G$ ) = 7 V/V,  $V_{CM}$  = mid-supply,  $R_F = 301\ \Omega$ ,  $R_L = 100\ \Omega$  to mid-supply, small-signal  $V_O = 100\text{ mV}_{PP}$ , large-signal  $V_O = 2\text{ V}_{PP}$  (unless otherwise noted).

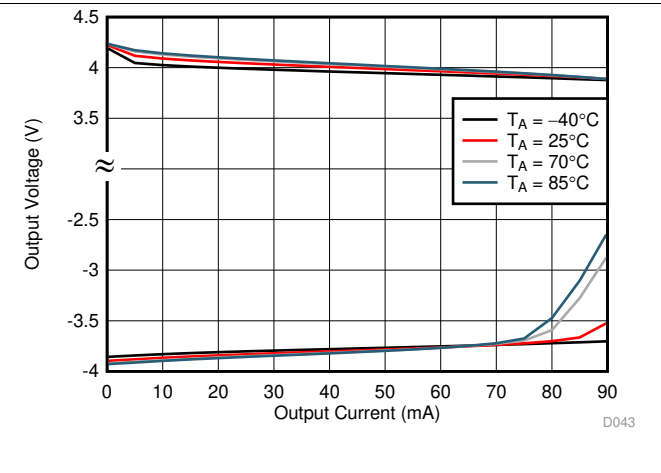


**Figure 25. Small-Signal Pulse Response**

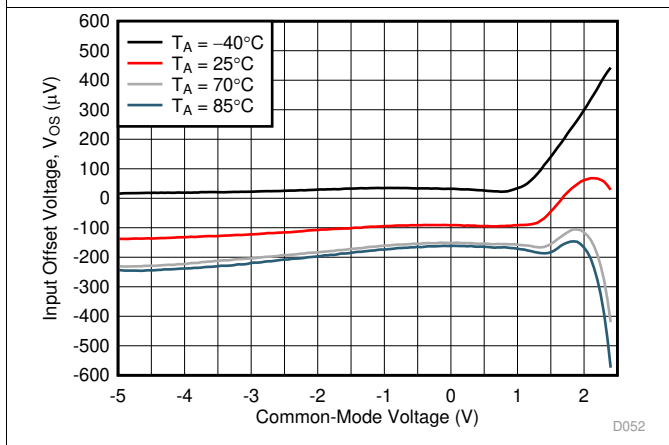
**Figure 26. Large-Signal Pulse Response**



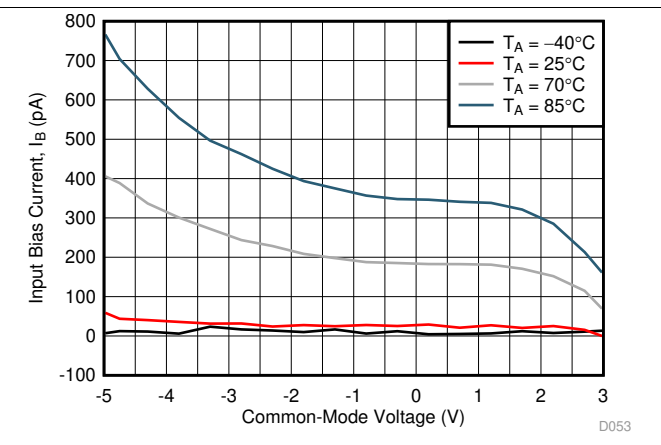
**Figure 27. Quiescent Current vs Voltage Supply Over Temperature**



**Figure 28. Output Voltage vs Output Current Over Temperature**



**Figure 29. Input Offset Voltage vs Common-Mode Voltage Over Temperature**



**Figure 30. Input Bias Current vs Common-Mode Voltage Over Temperature**

Typical Characteristics:  $V_S = \pm 5\text{ V}$  (continued)

At  $T_A \approx 25^\circ\text{C}$ ,  $V_{S+} = +5\text{ V}$ ,  $V_{S-} = -5\text{ V}$ , closed-loop gain ( $G$ ) = 7 V/V,  $V_{CM}$  = mid-supply,  $R_F = 301\ \Omega$ ,  $R_L = 100\ \Omega$  to mid-supply, small-signal  $V_O = 100\text{ mV}_{PP}$ , large-signal  $V_O = 2\text{ V}_{PP}$  (unless otherwise noted).

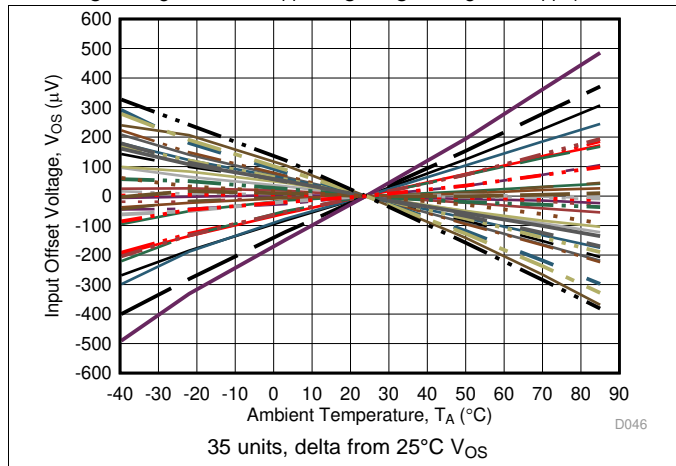


Figure 31. Input Offset Voltage vs Temperature

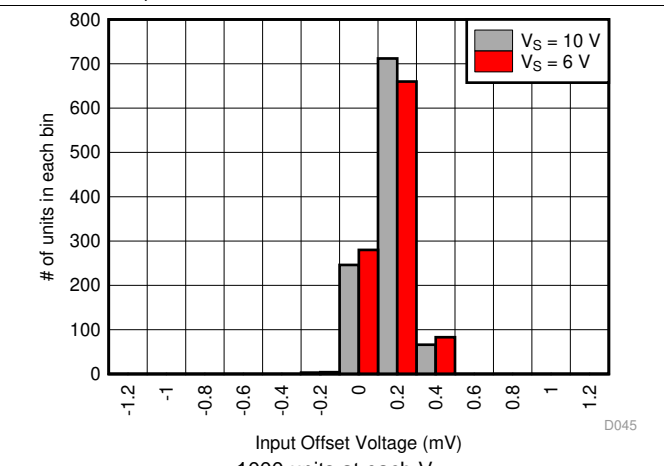


Figure 32. Input Offset Voltage Histogram

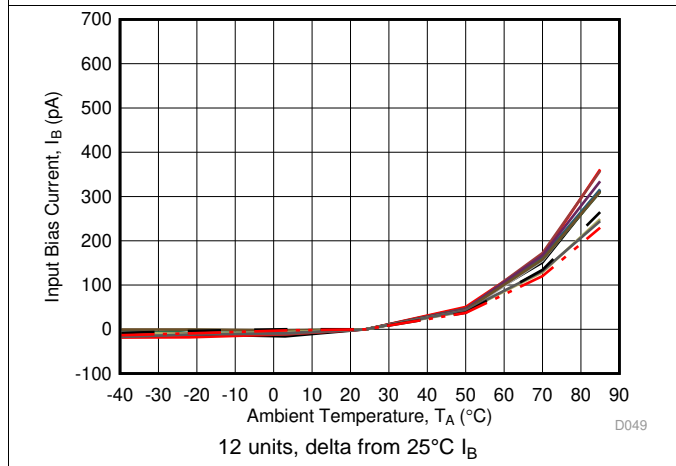


Figure 33. Input Bias Current vs Temperature

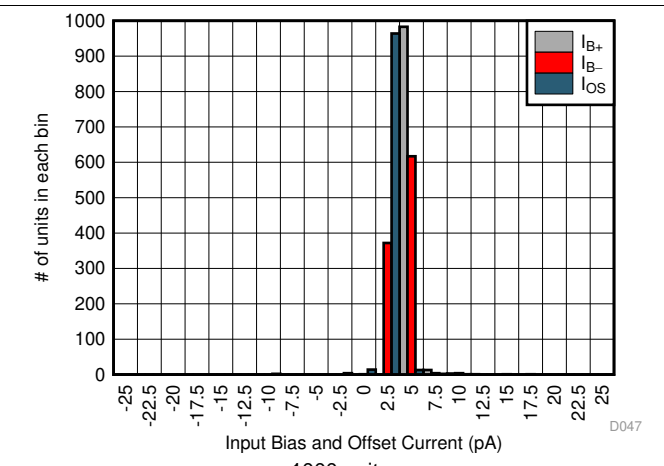


Figure 34. Input Bias and Offset Current Histogram

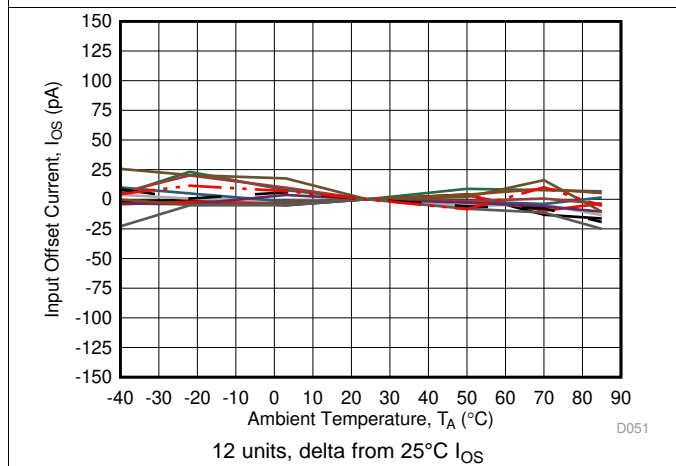


Figure 35. Input Offset Current vs Temperature

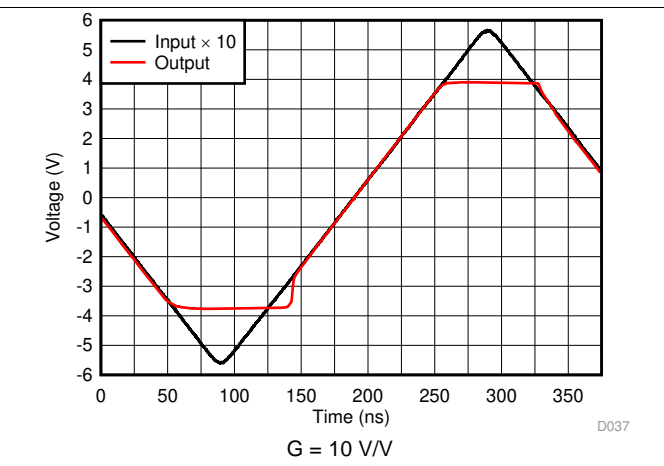


Figure 36. Output Overdrive Recovery

### 7.7 Typical Characteristics: $V_S = 6\text{ V}$

At  $T_A \approx 25^\circ\text{C}$ ,  $V_{S+} = +4\text{ V}$ ,  $V_{S-} = -2\text{ V}$ , closed-loop gain ( $G$ ) =  $7\text{ V/V}$ ,  $V_{CM}$  = mid-supply,  $R_F = 301\ \Omega$ ,  $R_L = 100\ \Omega$  to mid-supply, small-signal  $V_O = 100\text{ mV}_{PP}$ , large-signal  $V_O = 1\text{ V}_{PP}$  (unless otherwise noted).

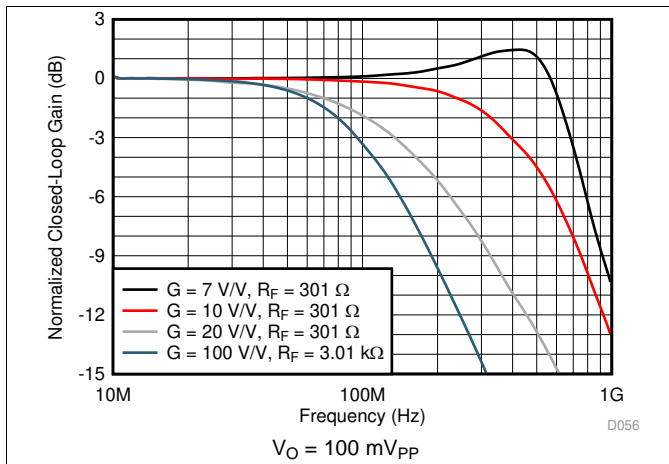


Figure 37. Non-Inverting Small-Signal Frequency Response

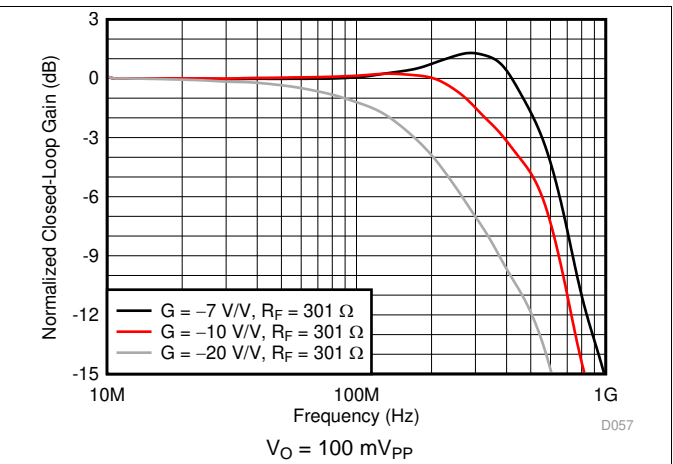


Figure 38. Inverting Small-Signal Frequency Response

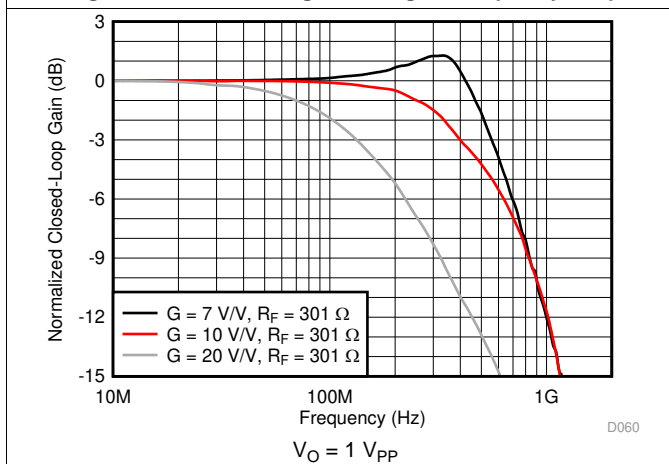


Figure 39. Non-Inverting Large-Signal Frequency Response

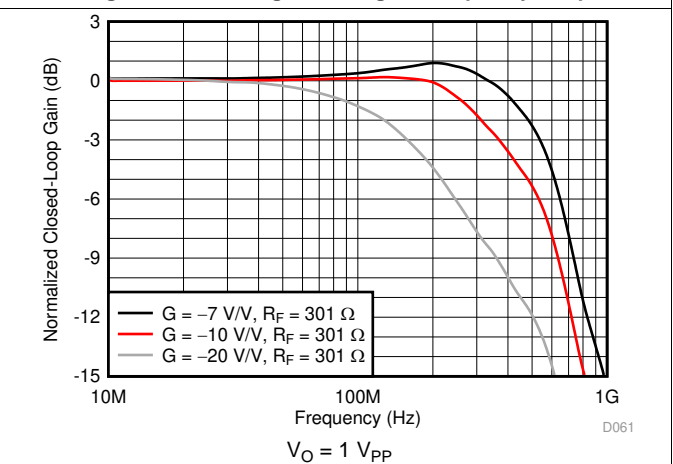


Figure 40. Inverting Large-Signal Frequency Response

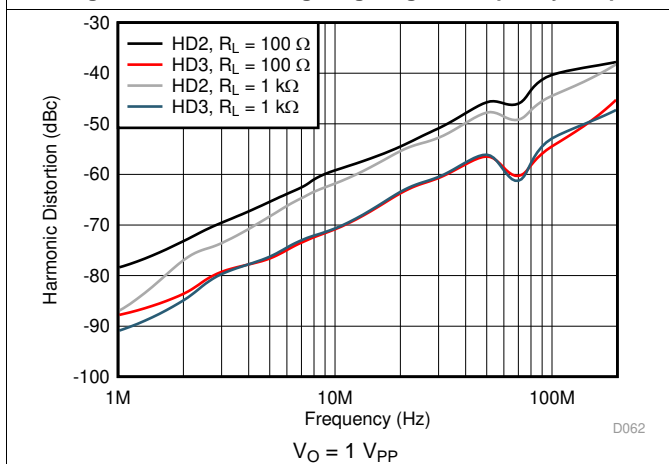


Figure 41. Harmonic Distortion vs Frequency Over  $R_L$

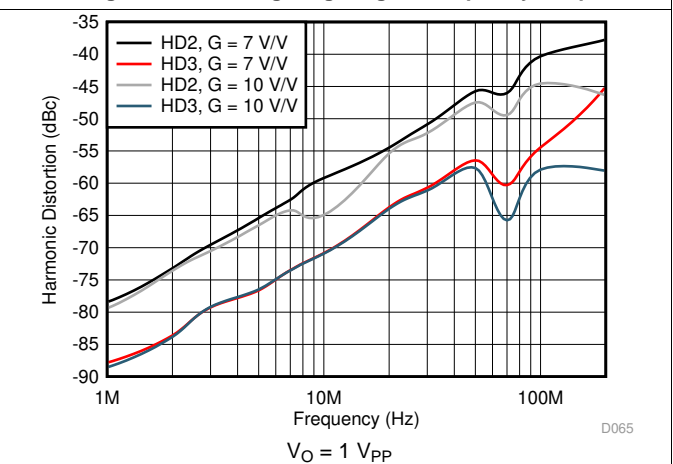


Figure 42. Harmonic Distortion vs Frequency Over Gain

## 8 Detailed Description

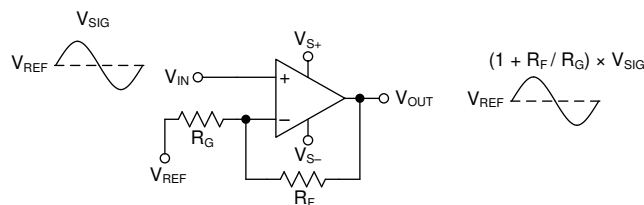
### 8.1 Overview

The OPA818 is a 13 V supply, 2.7 GHz gain-bandwidth product (GBWP), voltage feedback operational amplifier (op amp) featuring a 2.2 nV/√Hz low noise JFET input stage. The OPA818 is decompensated to be normally stable in gains  $\geq 7$  V/V. The decompensated architecture allows for a favorable tradeoff of low quiescent current for a very high GBWP and low distortion performance in high gain applications. The high voltage capability combined with 1400 V/μs slew rate enables applications needing wide output swings (10 V<sub>PP</sub> at V<sub>S</sub> = 12 V) for high frequency signals such as those often found in optical front-end, test and measurement applications, and medical systems. The low noise JFET input with pico amperes of bias current makes the device particularly attractive for high transimpedance gain TIA applications and for test and measurement front-ends. OPA818 also features power down mode that disables the core amplifier for power savings.

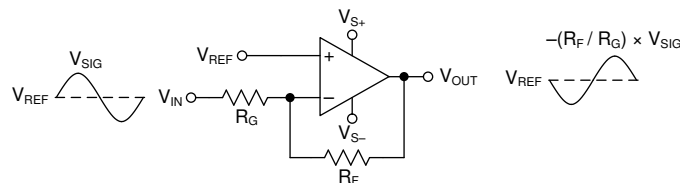
OPA818 is built using TI's proprietary high-voltage high-speed complementary bipolar SiGe process.

### 8.2 Functional Block Diagram

The OPA818 is a conventional voltage feedback op amp with two high-impedance inputs and a low-impedance output. Standard amplifier configurations are supported like the two basic configurations shown in [Figure 43](#) and [Figure 44](#). The DC operating point for each configuration is level-shifted by the reference voltage (V<sub>REF</sub>), which is typically set to mid-supply in single-supply operation. V<sub>REF</sub> is typically set to ground in split-supply applications.



**Figure 43. Non-Inverting Amplifier**



**Figure 44. Inverting Amplifier**

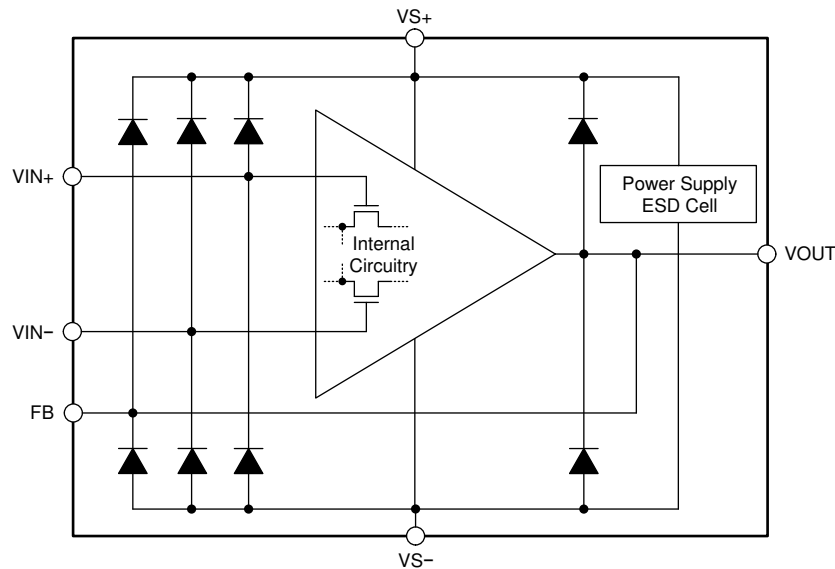
### 8.3 Feature Description

#### 8.3.1 Input and ESD Protection

The OPA818 is built using a very high speed complementary bipolar process. The internal junction breakdown voltages are relatively low for these very small geometry devices. These breakdowns are reflected in the [Absolute Maximum Ratings](#) table. All device pins are protected with internal ESD protection diodes to the power supplies as shown in [Figure 45](#).

These diodes provide moderate protection to input overdrive voltages beyond the supplies as well. The protection diodes can typically support 10-mA continuous current. Where higher currents are possible (for example, in systems with ±12-V supply parts driving into the OPA818), current limiting series resistors should be added in series with the two inputs to limit the current. Keep these resistor values as low as possible because high values degrade both noise performance and frequency response. There are no back-to-back ESD diodes between V<sub>IN+</sub> and V<sub>IN-</sub>. As a result, the differential input voltage between V<sub>IN+</sub> and V<sub>IN-</sub> is entirely absorbed by the V<sub>GS</sub> of the input JFET differential pair and must not exceed the voltage ratings shown in [Absolute Maximum Ratings](#) table.

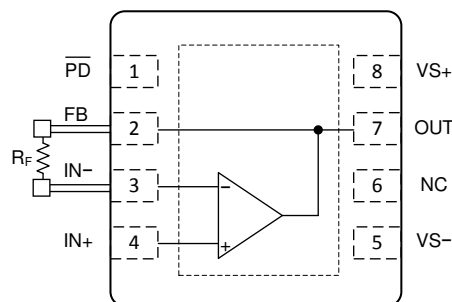
**Feature Description (continued)**



**Figure 45. Internal ESD Protection**

**8.3.2 Feedback Pin**

For high speed analog design, minimizing parasitic capacitances and inductances is critical to get the best performance from a high speed amplifier such as the OPA818. Parasitics are especially detrimental in the feedback path and at the inverting input. They result in undesired poles and zeroes in the feedback that could result in reduced phase margin or instability. Techniques used to correct for this phase margin reduction often result in reduced application bandwidth. To keep system engineers from making these tradeoff choices and to simplify the PCB layout, OPA818 features an FB pin on the same side as the inverting input pin, IN-. This allows for a very short feedback resistor,  $R_F$ , connection between the FB and the IN- pin as shown in Figure 46, thus minimizing parasitics with minimal PCB design effort. Internally the FB pin is connected to VOUT through metal routing on the silicon. Due to the fixed metal sizing of this connection, FB pin has limited current carrying capability and specifications in the *Absolute Maximum Ratings* must be adhered to for continuous operation.



**Figure 46.  $R_F$  Connection Between FB and IN- Pins**

**8.3.3 Decompensated Architecture With Wide Gain-Bandwidth Product**

Figure 47 shows the open-loop gain and phase response of the OPA818. The GBWP of an op amp is measured in the 20 dB/decade constant slope region of the  $A_{OL}$  magnitude plot. The open-loop gain of 60 dB for the OPA818 is along this 20 dB/decade slope and the corresponding frequency intercept is at 2.7 MHz. Converting 60 dB to linear units (1000 V/V) and multiplying it with the 2.7 MHz frequency intercept gives the GBWP of OPA818 as 2.7 GHz. As can be inferred from the  $A_{OL}$  Bode plot, the second pole in the  $A_{OL}$  response occurs before  $A_{OL}$  magnitude drops below 0 dB (1 V/V). This results in phase change of more than 180° at 0 dB  $A_{OL}$ .



## Feature Description (continued)

indicating that the amplifier will not be stable in a gain of 1 V/V. Amplifiers like OPA818 that are not unity-gain stable are referred to as decompensated amplifiers. The decompensated architecture typically allows for higher GBWP, higher slew rate, and lower noise compared to a unity-gain stable amplifier with equivalent quiescent current. The additional advantage of the decompensated amplifier is better distortion performance at higher frequencies in high gain applications for comparable quiescent current to a unity-gain stable amplifier.

OPA818 is stable in noise gain of 7 V/V (16.9 dB) or higher in conventional gain circuits as shown in [Figure 43](#) and [Figure 44](#). It has 790 MHz of SSBW in this gain configuration with approximately 50° phase margin.

The high GBWP and low voltage and current noise of OPA818 make it a very suitable amplifier for wideband moderate to high transimpedance gain applications. Transimpedance gains of 50 kΩ or higher benefit from the low current noise JFET input. In a typical transimpedance (TIA) circuit as shown in [Figure 50](#), unity-gain stable amplifier is not a requirement. At low frequencies, the noise gain of TIA is 0 dB (1 V/V) and at high frequencies the noise gain is set by the ratio of the total input capacitance ( $C_{TOT}$ ) and the feedback capacitance ( $C_F$ ). To maximize TIA closed-loop bandwidth, the feedback capacitance is generally smaller than the total input capacitance. This results in the ratio of total input capacitance to the feedback capacitance to be greater than 1, which is ultimately the noise gain of the TIA at higher frequencies. The blog series, [What you need to know about transimpedance amplifiers – part 1](#) and [What you need to know about transimpedance amplifiers – part 2](#) describe TIA compensation techniques in greater detail.

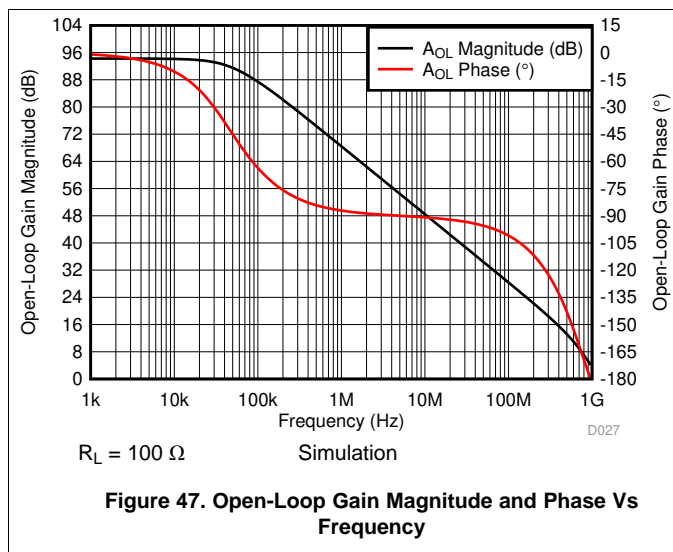


Figure 47. Open-Loop Gain Magnitude and Phase Vs Frequency

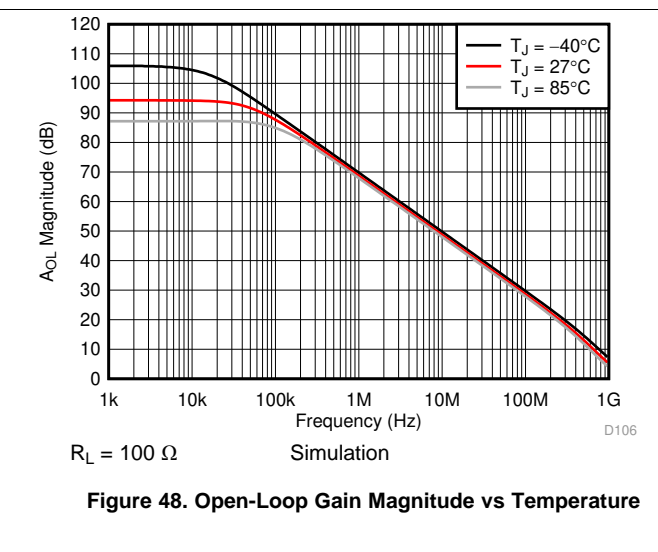


Figure 48. Open-Loop Gain Magnitude vs Temperature

### 8.3.4 Low Input Capacitance

Often two primary considerations for TIA applications are maximizing TIA closed-loop bandwidth and minimizing the total output noise to maximize Signal-to-Noise Ratio (SNR). The total input capacitance ( $C_{TOT}$ ) of TIA circuit causes a zero in the noise gain in combination with the transimpedance gain (feedback resistor,  $R_F$ ) at frequency  $1/(2\pi R_F C_{TOT})$ . For a fixed  $R_F$ , this zero is at a lower frequency for higher  $C_{TOT}$  thus increasing the noise gain at lower frequency resulting in lower equivalent closed-loop bandwidth and higher total output noise compared to a lower  $C_{TOT}$ . By choosing an amplifier like OPA818 that features a low input capacitance (2.4 pF combined common-mode and differential) for TIA application, the system designer can realize high closed-loop bandwidth at low total output noise or have the flexibility to choose a photodiode with relatively higher capacitance. The  $C_{TOT}$  includes the input capacitance of the amplifier, the photodiode capacitance, and the PCB parasitic capacitance at the inverting input.

## 8.4 Device Functional Modes

### 8.4.1 Split-Supply Operation (+4/–2 V to ±6.5 V)

In typical split-supply operation, the mid-point between the power rails is ground. Mid-point at ground in split-supply configuration is a valid operating condition for OPA818 when symmetric supply voltages that are greater than or equal to  $\pm 4$  V are used. This facilitates interfacing the OPA818 with common lab equipment such as signal generators, network analyzers, oscilloscopes, and spectrum analyzers most of which have inputs and outputs referenced to ground. However, when split-supply voltages less than  $\pm 4$  V are used, care must be taken that the input common-mode range is not violated because the typical input common-mode range of OPA818 includes  $V_{S-}$  and extends up to 3.2 V from  $V_{S+}$ . For example, when  $\pm 3$  V supplies are used, the input common-mode of the signal must be typically 3.2 V from  $V_{S+}$  and 3.6 V from  $V_{S+}$  under maximum specified input common-mode range. This means ground is not included in the input common-mode range with  $\pm 3$  V supplies resulting in erroneous operation if the input signal has ground as the mid-point. To prevent this situation, +4/–2 V supplies can be used.

### 8.4.2 Single-Supply Operation (6 V to 13 V)

Many newer systems use single power supply to improve efficiency and reduce the cost of the extra power supply. The OPA818 is designed for use with split-supply configuration; however, it can be used with a single-supply with no change in performance, as long as the input and output are biased within the linear operation of the device. To change the circuit from split supply to single supply, level shift all the voltages to mid-supply using  $V_{REF}$ . As described in [Split-Supply Operation \(+4/–2 V to ±6.5 V\)](#), additional consideration must be given to the input common-mode range so as not to violate it when operating with supplies less than 8 V. One of the advantages of configuring an amplifier for single-supply operation is that the effects of –PSRR will be minimized because the low supply rail has been grounded.

## 9 Application and Implementation

### NOTE

Information in the following applications sections is not part of the TI component specification, and TI does not warrant its accuracy or completeness. TI's customers are responsible for determining suitability of components for their purposes. Customers should validate and test their design implementation to confirm system functionality.

### 9.1 Application Information

#### 9.1.1 Wideband, Non-Inverting Operation

The OPA818 provides a unique combination of high GBWP, low-input voltage noise, and the DC precision of a trimmed JFET-input stage to provide an exceptional high input impedance for a voltage-feedback amplifier. Its very high GBWP of 2.7 GHz can be used to either deliver high-signal bandwidths at high gains, or to extend the achievable bandwidth or gain in photodiode-transimpedance applications. To achieve the full performance of the OPA818, careful attention to printed circuit board (PCB) layout and component selection is required as discussed in the following sections of this data sheet.

Figure 49 shows the non-inverting gain of +7 V/V circuit used as the basis for most of the *Typical Characteristics:  $V_S = \pm 5$  V*. Most of the curves were characterized using signal sources with 50- $\Omega$  driving impedance, and with measurement equipment presenting a 50- $\Omega$  load impedance. In Figure 49, the 49.9- $\Omega$  shunt resistor at the  $V_{IN}$  terminal matches the source impedance of the test generator, while the 49.9- $\Omega$  series resistor at the  $V_O$  terminal provides a matching resistor for the measurement equipment load. Generally, data sheet voltage swing specifications are at the output pin ( $V_O$  in Figure 49) while output power specifications are at the matched 50- $\Omega$  load. The total 100- $\Omega$  load at the output combined with the 350- $\Omega$  total feedback network load, presents the OPA818 with an effective output load of 78  $\Omega$  for the circuit of Figure 49.

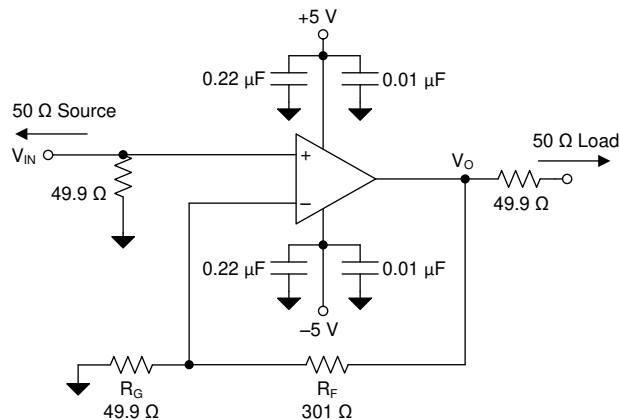


Figure 49. Non-Inverting  $G = +7$  V/V Configuration and Test Circuit

Voltage-feedback operational amplifiers, unlike current feedback products, can use a wide range of resistor values to set their gain. To retain a controlled frequency response for the non-inverting voltage amplifier of Figure 49, the parallel combination of  $R_F \parallel R_G$  should always be less than 50- $\Omega$ . In the non-inverting configuration, the parallel combination of  $R_F \parallel R_G$  will form a pole with the parasitic input capacitance at the inverting node of the OPA818 (including layout parasitics). For best performance, this pole should be at a frequency greater than the closed loop bandwidth for the OPA818.

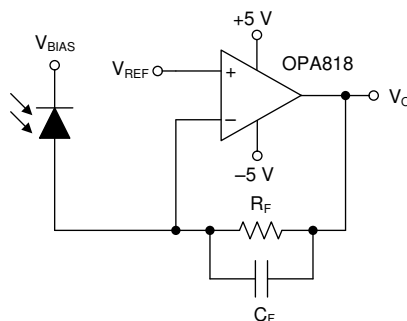
## Application Information (continued)

### 9.1.2 Wideband, Transimpedance Design Using OPA818

With high GBWP, low input voltage and current noise, and low input capacitance, the OPA818 design is optimized for wideband, low-noise transimpedance applications. The high voltage capability allows greater flexibility of supply voltages along with wider output voltage swings. [Figure 50](#) shows an example circuit of a typical photodiode amplifier circuit. Generally the photodiode is reverse biased in a TIA application so the photodiode current in the circuit of [Figure 50](#) flows into the op amp feedback loop resulting in an output voltage that reduces from  $V_{REF}$  with increasing photodiode current. In this type of configuration and depending on the application needs,  $V_{REF}$  can be biased closer to  $V_{S+}$  to achieve the desired output swing. Input common-mode range must be considered so as not to violate it when  $V_{REF}$  bias is used.

The key design elements that determine the closed-loop bandwidth,  $f_{-3dB}$ , of the circuit are below:

1. The op amp GBWP.
2. The transimpedance gain,  $R_F$ .
3. The total input capacitance,  $C_{TOT}$ , that includes photodiode capacitance, input capacitance of the amplifier (common-mode and differential capacitance), and PCB parasitic capacitance.



**Figure 50. Wideband, Low-Noise, Transimpedance Amplifier**

[Equation 1](#) shows the relationship between the above mentioned three elements for a Butterworth response.

$$f_{-3dB} = \sqrt{\frac{GBWP}{2\pi R_F C_{TOT}}} \quad (1)$$

The feedback resistance,  $R_F$  and the total input capacitance,  $C_{TOT}$  cause a zero in the noise gain that results in instability if left uncompensated. To counteract the effect of the zero, a pole is inserted in the noise gain by adding the feedback capacitor,  $C_F$ . The [Transimpedance Considerations for High-Speed Amplifiers](#) application report discusses theories and equations that show how to compensate a transimpedance amplifier for a particular gain and input capacitance. The bandwidth and compensation equations from the application report are available in a Microsoft Excel™ calculator. [What You Need To Know About Transimpedance Amplifiers – Part 1](#) provides a link to the calculator. The details of maximizing the dynamic range of TIA front-ends as shown in [High-Speed Optical Front-End](#) that uses voltages  $V_{REF1}$  and  $V_{REF2}$  are provided in [Maximizing the dynamic range of analog TIA front-end](#) application note.

## 9.2 Typical Applications

### 9.2.1 High Bandwidth, 100-kΩ Gain Transimpedance Design

The high GBWP and low input voltage and current noise for the OPA818 make it an excellent wideband transimpedance amplifier for moderate to high transimpedance gains.

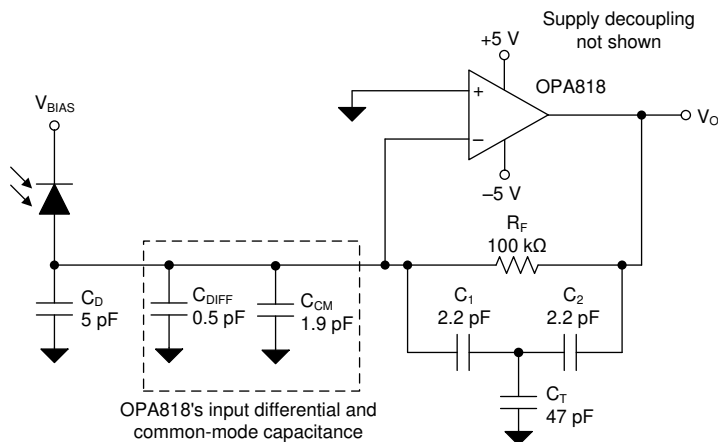


Figure 51. Wideband, High-Sensitivity, Transimpedance Amplifier

#### 9.2.1.1 Design Requirements

Design a high-bandwidth, high-transimpedance-gain amplifier with the design requirements shown in Table 1.

Table 1. Design Requirements

TARGET BANDWIDTH (MHz)	TRANSIMPEDANCE GAIN (kΩ)	PHOTODIODE CAPACITANCE (pF)
24	100	5

#### 9.2.1.2 Detailed Design Procedure

Designs that require high bandwidth from a large area detector with relatively high transimpedance gain benefit from the low input voltage noise of the OPA818. This input voltage noise is peaked up over frequency by the diode source capacitance, and can, in many cases, become the limiting factor to input sensitivity. Figure 51 shows the transimpedance circuit with the parameters as defined in Design Requirements. To use the Microsoft Excel™ calculator available at [What You Need To Know About Transimpedance Amplifiers – Part 1](#) to help with the component selection, total input capacitance,  $C_{TOT}$ , needs to be determined.  $C_{TOT}$  is referred as  $C_{IN}$  in the calculator.  $C_{TOT}$  is the sum of  $C_D$ ,  $C_{DIFF}$ , and  $C_{CM}$  which is 7.4 pF. Using this value of  $C_{TOT}$ , and the targeted closed-loop bandwidth ( $f_{-3dB}$ ) of 24 MHz and transimpedance gain of 100 kΩ results in a need for an amplifier with approximately 2.68 GHz GBWP and a feedback capacitance ( $C_F$ ) of 0.092 pF as shown in Figure 52. These results are for a Butterworth response with a  $Q = 0.707$  and a phase margin of approximately 65° which corresponds to 4.3% overshoot.

<u>Calculator II</u>		
Closed-loop TIA Bandwidth ( $f_{-3dB}$ )	24.00	<u>MHz</u>
Feedback Resistance ( $R_F$ )	100.00	<u>kOhm</u>
Input Capacitance ( $C_{IN}$ )	7.40	<u>pF</u>
Opamp Gain Bandwidth Product (GBP)	2678.14	<u>MHz</u>
Feedback Capacitance ( $C_F$ )	0.092	<u>pF</u>

Figure 52. Results of Inputting Design Parameters in the TIA Calculator

With OPA818's 2.7 GHz GBWP, it will be a suitable amplifier for the design requirements. A challenge with the calculated component results is practically realizing a 0.092 pF capacitor. Such a small capacitor can be realized by using a capacitive tee network formed by  $C_1$ ,  $C_2$ , and  $C_T$  such as that shown in Figure 51. The equivalent capacitance,  $C_{EQ}$ , of the tee network is given by Equation 2.

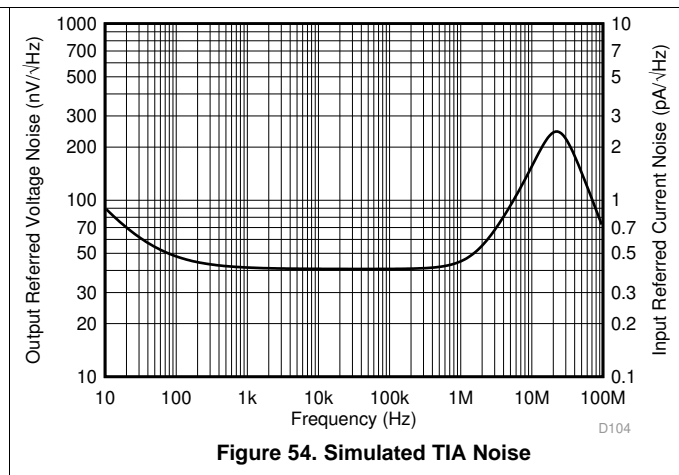
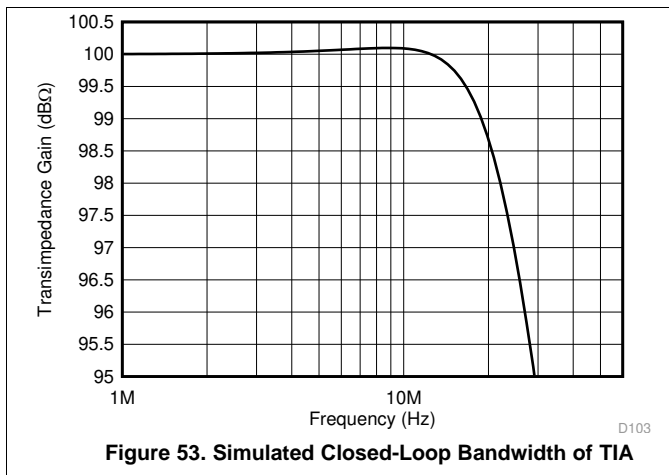
$$C_{EQ} = \frac{C_1 \times C_2}{C_1 + C_2 + C_T} \quad (2)$$

The tee network forms a capacitive attenuator from input to output with  $C_1$  and  $C_T$ , and from output to input with  $C_2$  and  $C_T$ . With the value of  $C_T$  being higher than  $C_1$  or  $C_2$ , only a fraction of the output signal is seen by  $C_1$ . This results in a much smaller shunting current provided to the input through  $C_1$  and this reduced shunting current effect is equivalent to how a much smaller capacitor behaves (at a fixed frequency, smaller capacitor has higher impedance and thus reduced current). It is recommended to keep the same level of attenuation from input to output and vice versa. To find the appropriate capacitor values for the tee network, choose an arbitrarily low but practically realizable and equal values for capacitors  $C_1$  and  $C_2$ , set  $C_{EQ} = C_{TOT}$ , and use Equation 3 to get the value of the tunable capacitor,  $C_T$ . The values of capacitors  $C_1$ ,  $C_2$ , and  $C_T$  in Figure 51 were determined using this process.

$$C_T = \frac{C_1 \times C_2 - (C_1 + C_2) \times C_{EQ}}{C_{EQ}} \quad (3)$$

Figure 53 shows the TINA simulated closed-loop bandwidth response of the circuit in Figure 51. The circuit was designed for  $f_{-3dB} = 24$  MHz and the simulated closed-loop 3-dB frequency is 24.6 MHz with about 0.1 dB peaking. The OPA818 TINA model models the input common-mode and differential capacitors so they should not be added externally when simulating in TINA. The noise simulation of the TIA circuit is shown in Figure 54. The output referred voltage noise is shown on the Y-axis to the left and the input referred current noise, which is essentially output referred voltage noise divided by the transimpedance gain of 100k, is shown on the secondary Y-axis to the right. The simulation results are fairly accurate because the OPA818 TINA model closely models the voltage and current noise performance of the amplifier. The flat-band output voltage noise is 41 nV/ $\sqrt{Hz}$  that is equivalent to 0.41 pA/ $\sqrt{Hz}$  of input referred current noise. The noise in relatively low frequency region where the noise gain of the amplifier is 1 V/V is dominated by the thermal noise of the 100 k $\Omega$  resistor (40.7 nV/ $\sqrt{Hz}$  at 27°C). At mid frequencies beyond the zero formed by  $R_F$  and  $C_{TOT}$ , the noise gain of the amplifier amplifies the voltage noise of the amplifier. The amplifier's noise starts to become the dominant noise contributor from this frequency onwards before the output noise starts to roll off at frequencies beyond the 3-dB closed-loop bandwidth. When looked at integrated root-mean-square (RMS) noise, the mid-frequency noise will be a significant contributor and hence using a 2.2 nV/ $\sqrt{Hz}$  low-noise amplifier like OPA818 is advantageous to minimize total RMS noise in the system.

### 9.2.1.3 Application Curves



### 9.2.2 Non-Inverting Gain of 2 V/V

The OPA818 is normally stable in noise gain configurations of greater than 7 V/V when conventional feedback networks are used. The OPA818 can be configured in noise gains of less than 7 V/V by using capacitors in the feedback path and between the inputs to maintain the desired gain at lower frequencies and increase the noise gain at higher frequencies such that the amplifier is stable. Configuration (a) in Figure 55 shows OPA818 configured in a gain of 2 V/V by using capacitors and resistors to shape the noise gain and achieve a phase margin of approximately 51° that is very close to the phase margin achieved for the conventional 7 V/V configuration (b) in Figure 55.

The key benefit of using a decompensated amplifier such as the OPA818 below the minimum stable gain allows taking advantage of the low noise and low distortion performance at powers lower than comparable unity-gain stable architectures. The small-signal frequency response in Figure 55 shows flat AC performance beyond 100 MHz for gain of 2 V/V configuration (a) in Figure 57, and by being in a lower gain configuration versus the minimum stable gain configuration of 7 V/V, the output-referred total noise is also lower (64 nV/√Hz at 100 MHz) as shown in Figure 57 compared to that at 166 nV/√Hz of configuration (b). By reducing the 10-pF input capacitor, higher closed-loop bandwidth can be achieved at the expense of increased peaking and reduced phase margin. Low-capacitance layout by minimizing trace lengths and removing planes under the traces and components connected to the inverting input is critical to minimize parasitic capacitance (see *Layout Guidelines*). As small as 1 to 2 pF of parasitic capacitance on inverting input will require tweaking the noise-shaping component values to get flat frequency response and the desired phase margin. Configurations in Figure 55 does not take into account this parasitic capacitance but it must be considered for practical purposes. A 45° phase margin is generally acceptable but anything below 40° is not recommended to allow for component, PCB, and process tolerances. Details on the benefits of decompensated architectures are discussed in *Using a decompensated op amp for improved performance*.

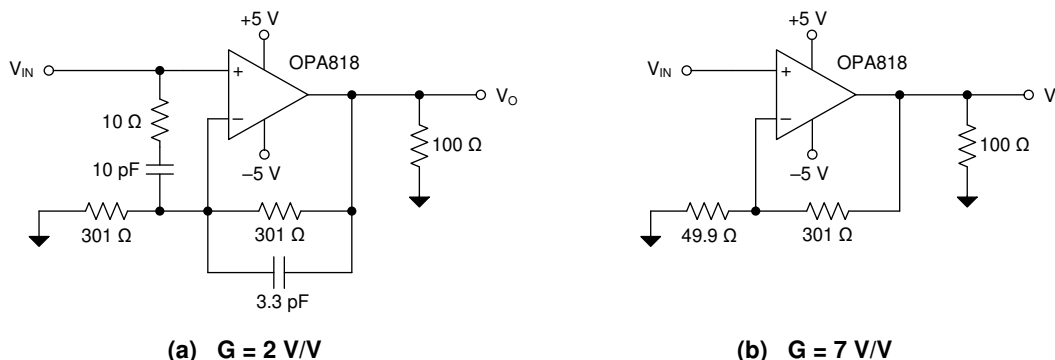


Figure 55. Non-Inverting Gain of 2 V/V and 7 V/V Configurations

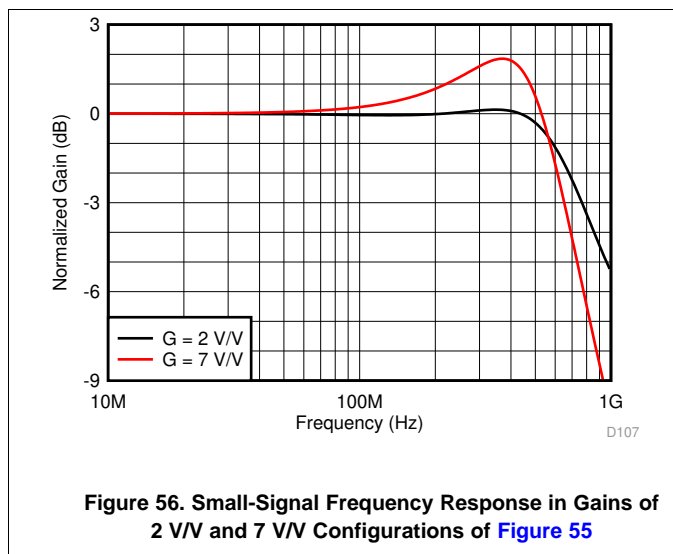


Figure 56. Small-Signal Frequency Response in Gains of 2 V/V and 7 V/V Configurations of Figure 55

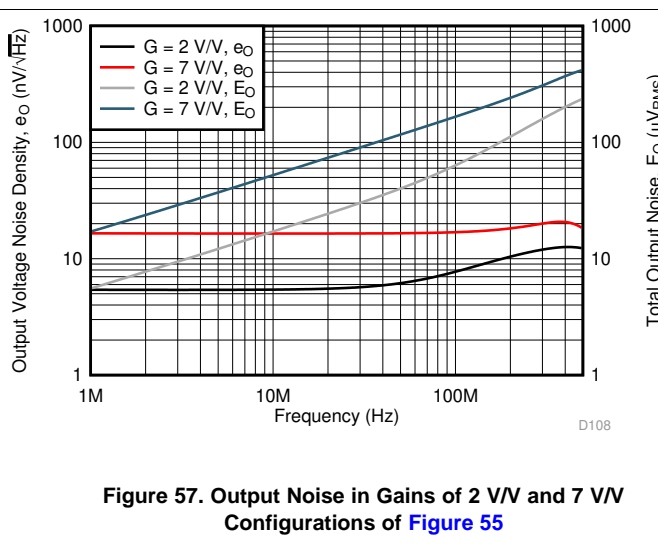


Figure 57. Output Noise in Gains of 2 V/V and 7 V/V Configurations of Figure 55



## 10 Power Supply Recommendations

The OPA818 is intended for operation on supplies from 6 V (+4/–2 V) to 12 V ( $\pm 6$  V). OPA818 supports single-supply, split and balanced bipolar supplies and unbalanced bipolar supplies. When operating at supplies below 8 V, the mid-supply will be outside the input common-mode range of the amplifier. Under these supply conditions, the common-mode must be biased appropriately for linear operation. Thus the limit to lower supply voltage operation is the useable input voltage range for the JFET-input stage. Operating from a single supply of 12 V can have numerous advantages. With the negative supply at ground, the DC errors due to the –PSRR term can be minimized. Typically, AC performance improves slightly at 12-V operation with minimal increase in supply current.



## 11 Layout

### 11.1 Layout Guidelines

Achieving optimum performance with a high-frequency amplifier like the OPA818 requires careful attention to board layout parasitics and external component types. Recommendations that will optimize performance include.

1. **Minimize parasitic capacitance** to any AC ground for all of the signal I/O pins. Parasitic capacitance on the output and inverting input pins can cause instability. On the non-inverting input, parasitic capacitance can react with the source impedance to cause unintentional bandlimiting. Ground and power metal planes act as one of the plates of a capacitor while the signal trace metal acts as the other separated by PCB dielectric. To reduce this unwanted capacitance, a plane cutout around and underneath the signal I/O pins on all ground and power planes is recommended. Otherwise, ground and power planes should be unbroken elsewhere on the board. When configuring the amplifier as a TIA, if the required feedback capacitor is under 0.15 pF, consider using two series resistors, each of half the value of a single resistor in the feedback loop to minimize the parasitic capacitance from the resistor.
2. **Minimize the distance** (less than 0.25-in) from the power-supply pins to high-frequency decoupling capacitors. Use high quality, 100-pF to 0.1- $\mu$ F, C0G and NPO-type decoupling capacitors with voltage ratings at least three times greater than the amplifiers maximum power supplies to ensure that there is a low-impedance path to the amplifiers power-supply pins across the amplifiers gain bandwidth specification. At the device pins, do not allow the ground and power plane layout to be in close proximity to the signal I/O pins. Avoid narrow power and ground traces to minimize inductance between the pins and the decoupling capacitors. The power-supply connections must always be decoupled with these capacitors. Larger (2.2- $\mu$ F to 6.8- $\mu$ F) decoupling capacitors, effective at lower frequency, must be used on the supply pins. These are placed further from the device and are shared among several devices in the same area of the PC board.
3. **Careful selection and placement of external components will preserve the high frequency performance of the OPA818.** Resistors should be of very low reactance type. Surface-mount resistors work best and allow a tighter overall layout. Metal film and carbon composition axially leaded resistors can also provide good high frequency performance. Again, keep their leads and PCB trace length as short as possible. Never use wirewound type resistors in a high frequency application. Because the output pin and inverting input pin are the most sensitive to parasitic capacitance, always position the feedback and series output resistor, if any, as close as possible to the inverting input and the output pin, respectively. Other network components, such as non-inverting input termination resistors, should also be placed close to the package. Even with a low parasitic capacitance shunting the external resistors, excessively high resistor values can create significant time constants that can degrade performance. When OPA818 is configured as a conventional voltage amplifier, keep the resistor values as low as possible and consistent with the load driving considerations. Lower resistor values minimize the effect of parasitic capacitance and reduce resistor noise terms but because the feedback network ( $R_F + R_G$  for non-inverting and  $R_F$  for inverting configuration) acts as a load on the amplifier, lower resistor values increase the dynamic power consumption and the effective load on the output stage. Transimpedance applications (see [Figure 50](#)) can use feedback resistors as required by the application and as long as the feedback compensation capacitor is set considering all parasitic capacitance terms on the inverting node.
4. **Heat dissipation is important for a high voltage device like OPA818.** For good thermal relief, the thermal pad should be connected to a heat spreading plane that is preferably on the same layer as OPA818 or connected by as many vias as possible if the plane is on a different layer. It is recommended to have at least one heat spreading plane on the same layer as the OPA818 that makes a direct connection to the thermal pad with wide metal for good thermal conduction when operating at high ambient temperatures. If more than one heat spreading planes are available, connecting them by a number of vias further improves the thermal conduction.
5. **Socketing a high speed part like the OPA818 is not recommended.** The additional lead length and pin-to-pin capacitance introduced by the socket can create an extremely troublesome parasitic network which can make it almost impossible to achieve a smooth, stable frequency response. Best results are obtained by soldering the OPA818 onto the board.

#### 11.1.1 Thermal Considerations

The OPA818 will not require heatsinking or airflow in most applications. Maximum allowed junction temperature will set the maximum allowed internal power dissipation as described below. In no case should the maximum junction temperature be allowed to exceed 105°C.

### Layout Guidelines (continued)

Operating junction temperature ( $T_J$ ) is given by  $T_A + P_D \times R_{\theta JA}$ . The total internal power dissipation ( $P_D$ ) is the sum of quiescent power ( $P_{DQ}$ ) and additional power dissipated in the output stage ( $P_{DL}$ ) to deliver load power. Quiescent power is simply the specified no-load supply current times the total supply voltage across the part.  $P_{DL}$  will depend on the required output signal and load but would, for a grounded resistive load, be at a maximum when the output is fixed at a voltage equal to 1/2 of either supply voltage (for balanced bipolar supplies). Under this condition  $P_{DL} = V_S^2 / (4 \times R_L)$  where  $R_L$  includes feedback network loading.

Note that it is the power in the output stage and not into the load that determines internal power dissipation.

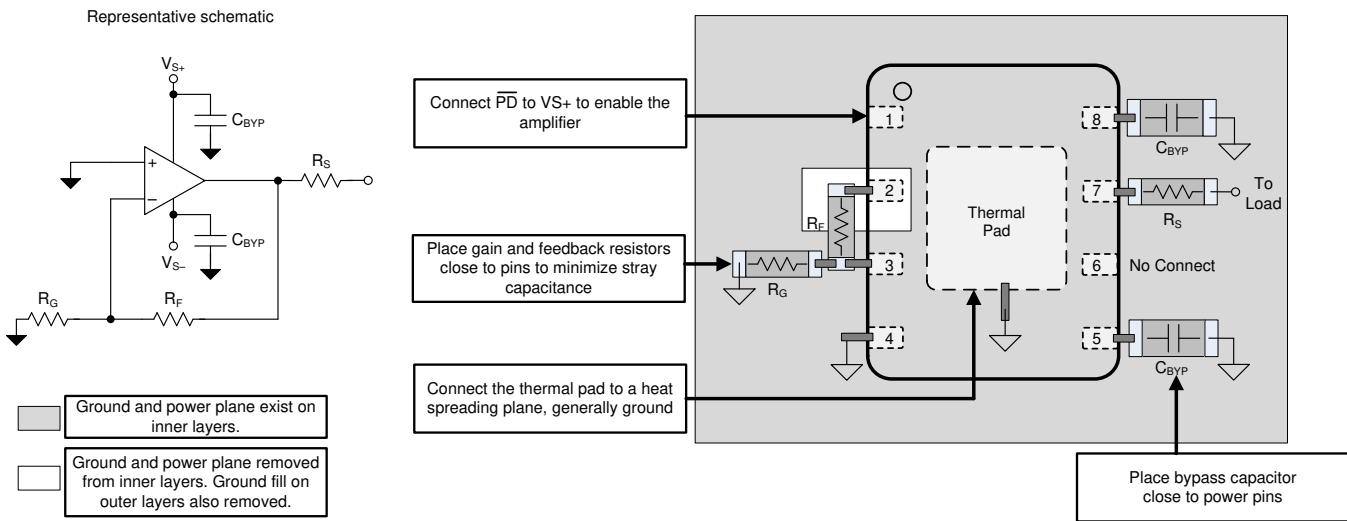
As a worst-case example, compute the maximum  $T_J$  using OPA818 in the circuit of [Figure 49](#) operating at the maximum specified ambient temperature of +85°C and driving a grounded 100-Ω load.

$$P_D = 10 \text{ V} \times 27.7 \text{ mA} + 5^2 / (4 \times (100 \text{ } \Omega \parallel 350.9 \text{ } \Omega)) \approx 357 \text{ mW}$$

$$\text{Maximum } T_J = 85^\circ\text{C} + (0.357 \text{ W} \times 54.6^\circ\text{C/W}) = 104.5^\circ\text{C}.$$

All actual applications will be operating at lower internal power and junction temperature.

### 11.2 Layout Example



**Figure 58. Layout Recommendation**

When configuring the OPA818 as a transimpedance amplifier additional care must be taken to minimize the inductance between the avalanche photodiode (APD) and the amplifier. Always place the photodiode on the same side of the PCB as the amplifier. Placing the amplifier and the APD on opposite sides of the PCB increases the parasitic effects due to via inductance. APD packaging can be quite large which often requires the APD to be placed further away from the amplifier than ideal. The added distance between the two device results in increased inductance between the APD and op amp feedback network as shown in [Equation 4](#). The added inductance is detrimental to a decompensated amplifier's stability since it isolates the APD capacitance from the noise gain transfer function. The noise gain is given by [Equation 4](#). The added PCB trace inductance between the feedback network increases the denominator in [Equation 4](#) thereby reducing the noise gain and the phase margin. In cases where a leaded APD in a TO can is used inductance should be further minimized by cutting the leads of the TO can as short as possible. Also, edge mounting the photodiode on the PCB should be considered versus through the hole if the application allows.

### Layout Example (continued)

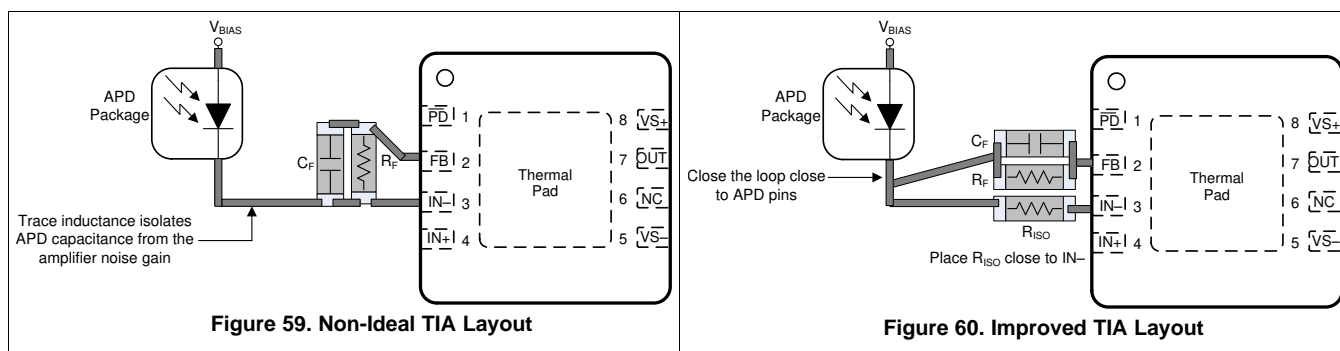
The layout shown in Figure 59 can be improved by following some of the guidelines shown in Figure 60. The two key rules to follow are:

- Add an isolation resistor  $R_{ISO}$  as close as possible to the inverting input of the amplifier. Select the value of  $R_{ISO}$  to be between  $10\ \Omega$  and  $20\ \Omega$ . The resistor dampens the potential resonance caused by the trace inductance and the amplifiers internal capacitance.
- Close the loop between the feedback elements ( $R_F$  and  $C_F$ ) and  $R_{ISO}$  as close to the APD pins as possible. This ensures a more balanced layout and reduces the inductive isolation between the APD and the feedback network.

$$\text{Noise Gain} = \left( 1 + \frac{Z_F}{Z_{IN}} \right)$$

where

- $Z_F$  is the total impedance of the feedback network
  - $Z_{IN}$  is the total impedance of the input network
- (4)



## 12 Device and Documentation Support

### 12.1 Device Support

#### 12.1.1 Development Support

- [Wide Bandwidth Optical Front-end Reference Design](#)

### 12.2 Documentation Support

#### 12.2.1 Related Documentation

For related documentation see the following:

- [OPA818EVM User's Guide](#)
- [Theory of decompensated amplifiers and stabilization techniques](#)
- [Using a decompensated op amp for improved performance](#)
- [Transimpedance Considerations for High-Speed Amplifiers Application Report](#)
- [Maximizing the dynamic range of analog TIA front-end](#)
- [What You Need To Know About Transimpedance Amplifiers – Part 1](#)
- [What You Need To Know About Transimpedance Amplifiers – Part 2](#)
- [Training Video: How to Design Transimpedance Amplifier Circuits](#)
- [Training Video: High-Speed Transimpedance Amplifier Design Flow](#)
- [Training Video: How to Convert a TINA-TI Model into a Generic SPICE Model](#)

### 12.3 Receiving Notification of Documentation Updates

To receive notification of documentation updates, navigate to the device product folder on ti.com. In the upper right corner, click on *Alert me* to register and receive a weekly digest of any product information that has changed. For change details, review the revision history included in any revised document.

### 12.4 Community Resources

[TI E2E™ support forums](#) are an engineer's go-to source for fast, verified answers and design help — straight from the experts. Search existing answers or ask your own question to get the quick design help you need.

Linked content is provided "AS IS" by the respective contributors. They do not constitute TI specifications and do not necessarily reflect TI's views; see TI's [Terms of Use](#).

### 12.5 Trademarks

E2E is a trademark of Texas Instruments.

### 12.6 Electrostatic Discharge Caution



This integrated circuit can be damaged by ESD. Texas Instruments recommends that all integrated circuits be handled with appropriate precautions. Failure to observe proper handling and installation procedures can cause damage.

ESD damage can range from subtle performance degradation to complete device failure. Precision integrated circuits may be more susceptible to damage because very small parametric changes could cause the device not to meet its published specifications.

### 12.7 Glossary

[SLYZ022](#) — *TI Glossary*.

This glossary lists and explains terms, acronyms, and definitions.

## 13 Mechanical, Packaging, and Orderable Information

The following pages include mechanical, packaging, and orderable information. This information is the most current data available for the designated devices. This data is subject to change without notice and revision of this document. For browser-based versions of this data sheet, refer to the left-hand navigation.

**PACKAGING INFORMATION**

Orderable Device	Status (1)	Package Type	Package Drawing	Pins	Package Qty	Eco Plan (2)	Lead finish/ Ball material (6)	MSL Peak Temp (3)	Op Temp (°C)	Device Marking (4/5)	Samples
OPA818IDRGR	ACTIVE	SON	DRG	8	3000	RoHS & Green	NIPDAU	Level-2-260C-1 YEAR	-40 to 125	OPA818	<a href="#">Samples</a>
OPA818IDRGT	ACTIVE	SON	DRG	8	250	RoHS & Green	NIPDAU	Level-2-260C-1 YEAR	-40 to 125	OPA818	<a href="#">Samples</a>

(1) The marketing status values are defined as follows:

**ACTIVE:** Product device recommended for new designs.

**LIFEBUY:** TI has announced that the device will be discontinued, and a lifetime-buy period is in effect.

**NRND:** Not recommended for new designs. Device is in production to support existing customers, but TI does not recommend using this part in a new design.

**PREVIEW:** Device has been announced but is not in production. Samples may or may not be available.

**OBsolete:** TI has discontinued the production of the device.

(2) **RoHS:** TI defines "RoHS" to mean semiconductor products that are compliant with the current EU RoHS requirements for all 10 RoHS substances, including the requirement that RoHS substance do not exceed 0.1% by weight in homogeneous materials. Where designed to be soldered at high temperatures, "RoHS" products are suitable for use in specified lead-free processes. TI may reference these types of products as "Pb-Free".

**RoHS Exempt:** TI defines "RoHS Exempt" to mean products that contain lead but are compliant with EU RoHS pursuant to a specific EU RoHS exemption.

**Green:** TI defines "Green" to mean the content of Chlorine (Cl) and Bromine (Br) based flame retardants meet JS709B low halogen requirements of <=1000ppm threshold. Antimony trioxide based flame retardants must also meet the <=1000ppm threshold requirement.

(3) MSL, Peak Temp. - The Moisture Sensitivity Level rating according to the JEDEC industry standard classifications, and peak solder temperature.

(4) There may be additional marking, which relates to the logo, the lot trace code information, or the environmental category on the device.

(5) Multiple Device Markings will be inside parentheses. Only one Device Marking contained in parentheses and separated by a "~" will appear on a device. If a line is indented then it is a continuation of the previous line and the two combined represent the entire Device Marking for that device.

(6) Lead finish/Ball material - Orderable Devices may have multiple material finish options. Finish options are separated by a vertical ruled line. Lead finish/Ball material values may wrap to two lines if the finish value exceeds the maximum column width.

**Important Information and Disclaimer:**The information provided on this page represents TI's knowledge and belief as of the date that it is provided. TI bases its knowledge and belief on information provided by third parties, and makes no representation or warranty as to the accuracy of such information. Efforts are underway to better integrate information from third parties. TI has taken and continues to take reasonable steps to provide representative and accurate information but may not have conducted destructive testing or chemical analysis on incoming materials and chemicals. TI and TI suppliers consider certain information to be proprietary, and thus CAS numbers and other limited information may not be available for release.

In no event shall TI's liability arising out of such information exceed the total purchase price of the TI part(s) at issue in this document sold by TI to Customer on an annual basis.



**TAPE AND REEL INFORMATION**

**QUADRANT ASSIGNMENTS FOR PIN 1 ORIENTATION IN TAPE**


\*All dimensions are nominal

Device	Package Type	Package Drawing	Pins	SPQ	Reel Diameter (mm)	Reel Width W1 (mm)	A0 (mm)	B0 (mm)	K0 (mm)	P1 (mm)	W (mm)	Pin1 Quadrant
OPA818IDRGR	SON	DRG	8	3000	330.0	12.4	3.3	3.3	1.1	8.0	12.0	Q2
OPA818IDRGT	SON	DRG	8	250	180.0	12.4	3.3	3.3	1.1	8.0	12.0	Q2

**TAPE AND REEL BOX DIMENSIONS**

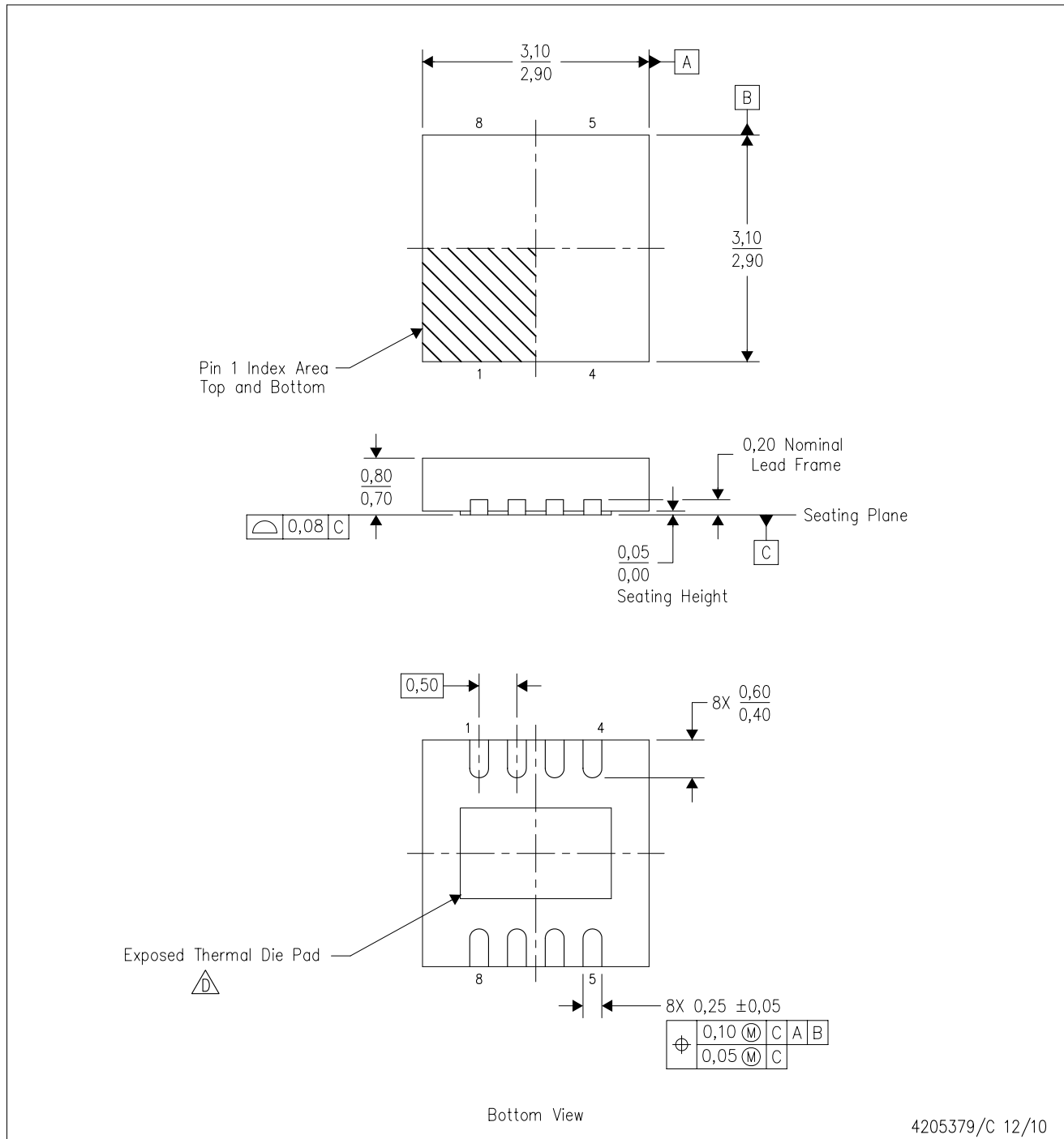

\*All dimensions are nominal

Device	Package Type	Package Drawing	Pins	SPQ	Length (mm)	Width (mm)	Height (mm)
OPA818IDRGR	SON	DRG	8	3000	367.0	367.0	35.0
OPA818IDRGT	SON	DRG	8	250	210.0	185.0	35.0

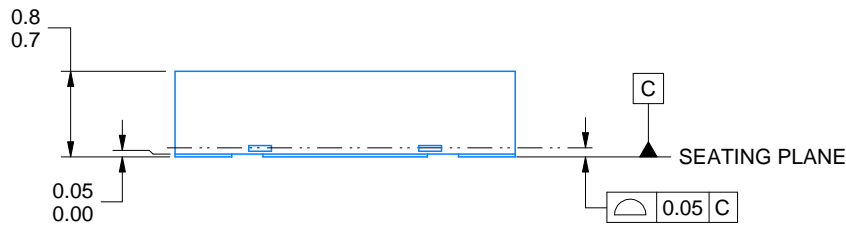
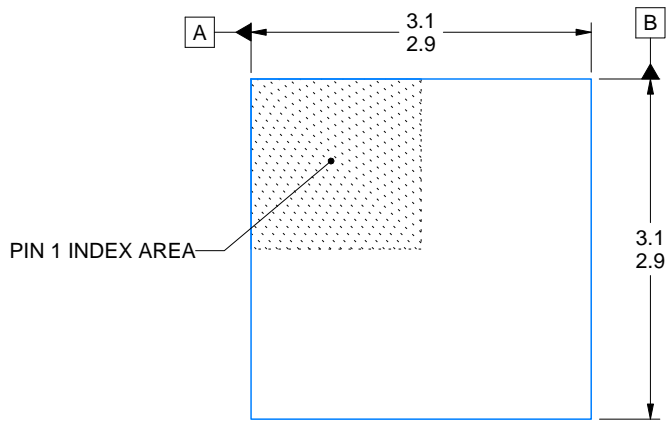
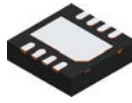


DRG (S-PWSON-N8)

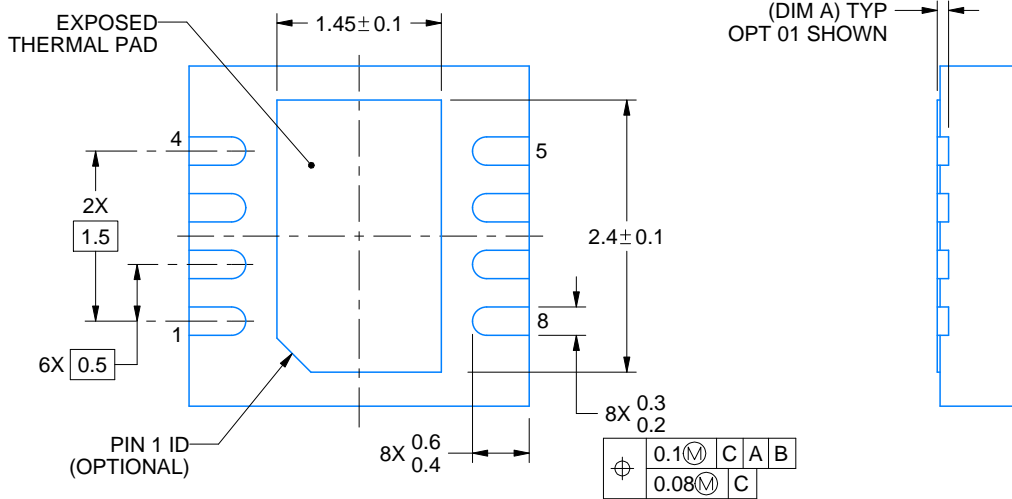
PLASTIC SMALL OUTLINE NO-LEAD



- NOTES:
- A. All linear dimensions are in millimeters. Dimensioning and tolerancing per ASME Y14.5M-1994.
  - B. This drawing is subject to change without notice.
  - C. SON (Small Outline No-Lead) package configuration.
  - D. The package thermal pad must be soldered to the board for thermal and mechanical performance. See the Product Data Sheet for details regarding the exposed thermal pad dimensions.
  - E. JEDEC MO-229 package registration pending.



DIMENSION A	
OPTION 01	(0.1)
OPTION 02	(0.2)



4218886/A 01/2020

NOTES:

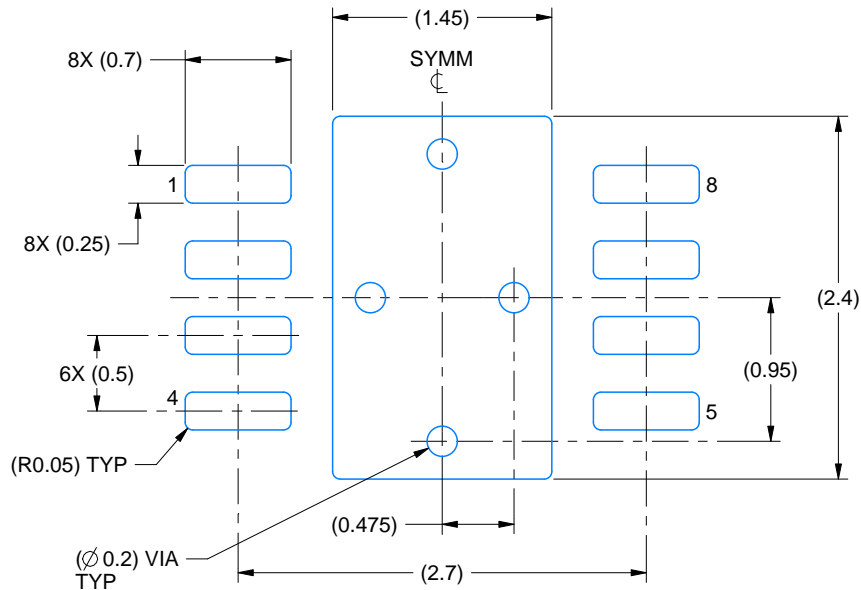
1. All linear dimensions are in millimeters. Any dimensions in parenthesis are for reference only. Dimensioning and tolerancing per ASME Y14.5M.
2. This drawing is subject to change without notice.
3. The package thermal pad must be soldered to the printed circuit board for thermal and mechanical performance.

# EXAMPLE BOARD LAYOUT

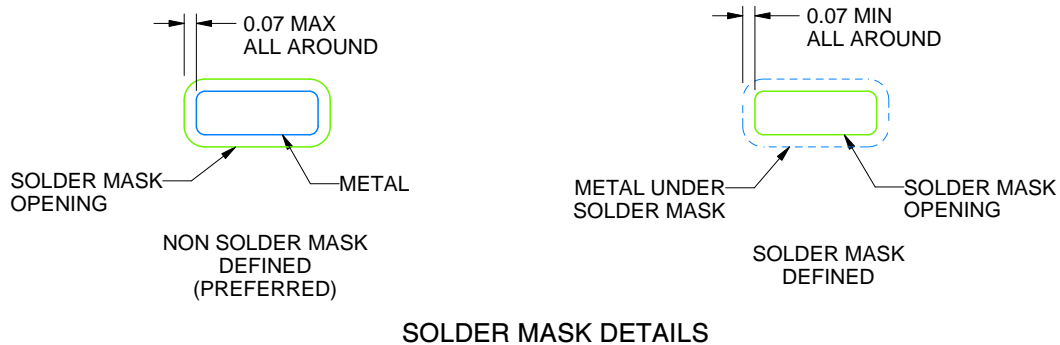
DRG0008B

WSON - 0.8 mm max height

PLASTIC SMALL OUTLINE - NO LEAD



LAND PATTERN EXAMPLE  
SCALE:20X



SOLDER MASK DETAILS

4218886/A 01/2020

NOTES: (continued)

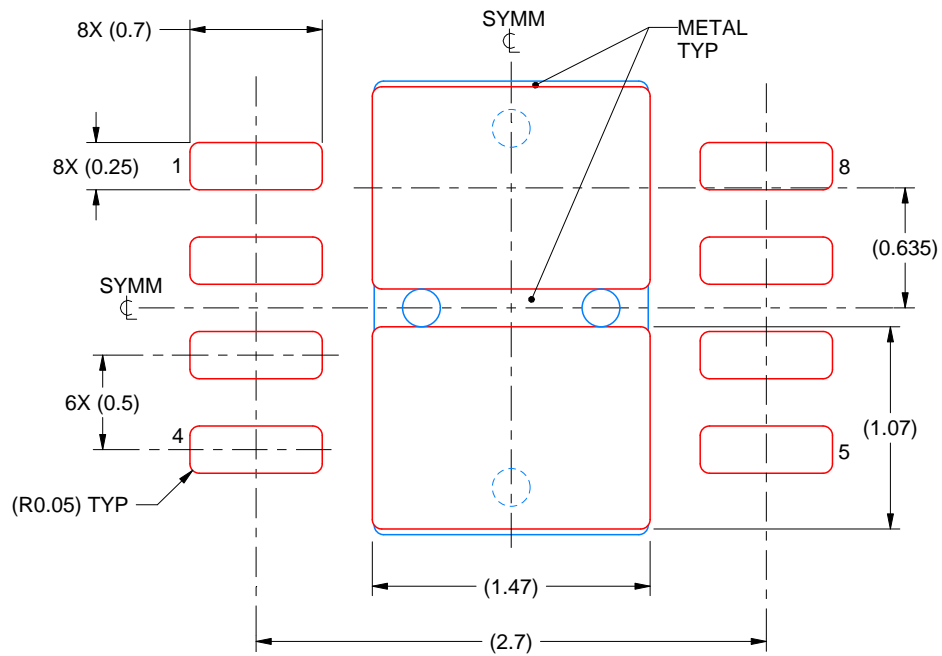
4. This package is designed to be soldered to a thermal pad on the board. For more information, see Texas Instruments literature number SLUA271 ([www.ti.com/lit/slua271](http://www.ti.com/lit/slua271)).
5. Vias are optional depending on application, refer to device data sheet. If any vias are implemented, refer to their locations shown on this view. It is recommended that vias under paste be filled, plugged or tented.

# EXAMPLE STENCIL DESIGN

DRG0008B

WSO - 0.8 mm max height

PLASTIC SMALL OUTLINE - NO LEAD



SOLDER PASTE EXAMPLE  
BASED ON 0.125 mm THICK STENCIL

EXPOSED PAD  
82% PRINTED SOLDER COVERAGE BY AREA  
SCALE:25X

4218886/A 01/2020

NOTES: (continued)

6. Laser cutting apertures with trapezoidal walls and rounded corners may offer better paste release. IPC-7525 may have alternate design recommendations.

## IMPORTANT NOTICE AND DISCLAIMER

TI PROVIDES TECHNICAL AND RELIABILITY DATA (INCLUDING DATA SHEETS), DESIGN RESOURCES (INCLUDING REFERENCE DESIGNS), APPLICATION OR OTHER DESIGN ADVICE, WEB TOOLS, SAFETY INFORMATION, AND OTHER RESOURCES "AS IS" AND WITH ALL FAULTS, AND DISCLAIMS ALL WARRANTIES, EXPRESS AND IMPLIED, INCLUDING WITHOUT LIMITATION ANY IMPLIED WARRANTIES OF MERCHANTABILITY, FITNESS FOR A PARTICULAR PURPOSE OR NON-INFRINGEMENT OF THIRD PARTY INTELLECTUAL PROPERTY RIGHTS.

These resources are intended for skilled developers designing with TI products. You are solely responsible for (1) selecting the appropriate TI products for your application, (2) designing, validating and testing your application, and (3) ensuring your application meets applicable standards, and any other safety, security, regulatory or other requirements.

These resources are subject to change without notice. TI grants you permission to use these resources only for development of an application that uses the TI products described in the resource. Other reproduction and display of these resources is prohibited. No license is granted to any other TI intellectual property right or to any third party intellectual property right. TI disclaims responsibility for, and you will fully indemnify TI and its representatives against, any claims, damages, costs, losses, and liabilities arising out of your use of these resources.

TI's products are provided subject to [TI's Terms of Sale](#) or other applicable terms available either on [ti.com](http://ti.com) or provided in conjunction with such TI products. TI's provision of these resources does not expand or otherwise alter TI's applicable warranties or warranty disclaimers for TI products.

TI objects to and rejects any additional or different terms you may have proposed.

Mailing Address: Texas Instruments, Post Office Box 655303, Dallas, Texas 75265  
Copyright © 2022, Texas Instruments Incorporated